



Cell Illustrator™: User Guide

**© 2002-2008 Human Genome Center, Institute of Medical Science,
The University of Tokyo
All rights reserved.**

TABLE OF CONTENTS:

1 INTRODUCTION	4
2 GETTING STARTED	5
2.1 Cell Illustrator Online	5
2.2 Run Cell Illustrator Online (CIO).....	5
2.3 Licensing Information.....	6
2.4 CI Memory Customization.....	7
3 CELL ILLUSTRATOR ELEMENTS	8
3.1 Concept Overview.....	8
3.2 Entities.....	9
3.3 Connectors.....	10
3.4 Processes.....	11
3.5 Element Combinations	12
3.6 Discrete Elements Example 1.....	14
3.7 Discrete Elements Example 2: Connector Speed.....	15
3.8 Continuous Elements Example 1.....	16
3.9 Continuous Elements Example 2.....	18
4 BIOLOGICAL PROCESS MODELING WITH CELL ILLUSTRATOR	21
4.1 Degradation.....	21
4.2 Translocation.....	23
4.3 Transcription.....	24
4.4 Complex.....	26
4.5 Tetramerization.....	29
4.6 Stochastic Tetramerization.....	30
4.7 Custom Tetramerization.....	31
4.8 Separation.....	32
4.9 Inhibition.....	34
4.10 Catalysis.....	36
5 CELL ILLUSTRATOR USER INTERFACE AND MODEL CREATION	40
5.1 Add Elements.....	40
5.2 Modify a Model	41
5.3 Change Element Properties	42
5.4 Element Settings Dialog and Element Lists Dialog.....	44
5.5 Biological Elements and Pathway Fragments.....	51
5.6 Script Editor and Pnuts Scripts.....	55
5.7 Preferences Dialog.....	59
5.8 Graph Layout Dialog.....	60
6 SIMULATION	61
6.1 Simulation Concept.....	61

6.2 How to Set Up and Run Simulation.....	63
6.3 Viewing and Analyzing Simulation Results.....	68
6.4 Running SECG Simulation.....	70
6.5 Remote Simulation Servers.....	72
6.6 Customized Simulation Engine.....	74
7 TOOLS FOR MODEL ANALYSIS.....	75
7.1 Navigator.....	75
7.2 Finder.....	76
7.3 Print and Print Area.....	77
7.4 Export Options.....	78
8 MAKING COMPLEX MODELS.....	79
8.1 Grouping and Ungrouping.....	79
8.2 Hierarchization.....	79
8.3 Edit Parts.....	81
8.4 BioPACS.....	82
8.5 Import of CellML or SBML models.....	82
8.6 Import of CSO and BioPAX models.....	83
9 CELL ILLUSTRATOR PLAYER.....	84
10 CELL ANIMATOR.....	86
APPENDIX A:	
TUTORIAL—MODELING FAS LIGAND INDUCED APOPTOSIS.....	87
APPENDIX B: USING DIFFERENTIAL EQUATIONS IN CI.....	94
CI REFERENCES.....	97

1 Introduction

Cell Illustrator™ (CI) is a software tool that enables biologists to model, elucidate and simulate complex biological processes and systems [11]. It allows researchers to model metabolic pathways, signal transduction cascades, gene regulatory pathways as well as dynamic interactions of various biological entities such as genomic DNA, mRNA and proteins. Cell Illustrator models are used to visualize biopathways, interpret experimental data and test hypotheses. In addition, it provides researchers with model diagrams of publication quality and simulation result charts. Cell Illustrator has been successfully utilized to model biological pathways like Circadian Rhythms of *Drosophila*, Glycolytic pathway and Fas ligand induced Apoptosis [1, 2, 3, 4, 5, 6, and 7].

Using the graphical user interface of Cell Illustrator, researchers can create and simulate their own molecular pathway models. Some of the key features of Cell Illustrator are: (a) Pathway construction and visualization—construct models graphically by drag and drop entities that represent bio-components in the biological pathways; (b) Pathways simulation—specify mathematical formulas for biochemical reactions in the pathway for simulation; The simulation can be run inside the workspace window in an interactive mode, or sent to a remote server (Cell Illustrator Server) (c) Simulation replay – the simulation results can be logged and then visualized and analyzed in Cell Illustrator Player; (d) Simulation animation—Cell Illustrator’s simulation results can be edited into an animation script file and then be used as the input to Cell Animator—a module that produces high quality presentation of the studied mechanism’s dynamic behavior; (e) Model import - previously created models or sub-models can be imported from SBML, CellML files or from public or proprietary libraries and databases like KEGG [9,12].

The documentation for the Cell Illustrator software includes the manuals listed below:

Cell Illustrator User Manual: Introduction to Cell Illustrator system

Cell Illustrator Reference Manual: Detailed description of Cell Illustrator functionalities

Cell Illustrator Player Reference Manual: Detailed description of Cell Illustrator Player functionalities

This manual describes version 4.0 of Cell Illustrator Online (CIO4.0).

2 Getting Started

2.1 Cell Illustrator Online

Cell Illustrator version 4.0 is available as a Java Web Start application – *CI Online*. CI Online can be run directly from the website, without the need to install software on local computer.

CI Online is a client-server solution that enables the user to create, manipulate and simulate bio-pathway models locally within CI workspace and to store and organize them on the remote CI Online Server. Additionally CI Online Server gives the user convenient access to libraries and databases of bio-pathway models.

2.2 Run Cell Illustrator Online (CIO)

In order to run Cell Illustrator correctly, Java version j2sdk 1.5.0 or higher needs to be installed. Java Runtime Environments (JREs) are available for download at: <http://java.sun.com/downloads>. To run Cell Illustrator Online:

- Open the Cell Illustrator Online website at <http://cio.biobase.de/> or <https://cionline.hgc.jp> in your web browser

https://cionline.hgc.jp/

CIO 4.0
Cell Illustrator Online 4.0

Main menu

- Registration
- Cell Illustrator
- Cell Illustrator Player

Java Web Start is required to run CIO. Download the latest Java Runtime Environment (JRE), which includes Java Web Start and install it on your PC. Get your login account through the registration and try CIO. If you are already registered you can [check your license status](#).

Copyright © 2007 by GNI Ltd. and The University of Tokyo

- Register to obtain the CI Online account

- Run Cell Illustrator

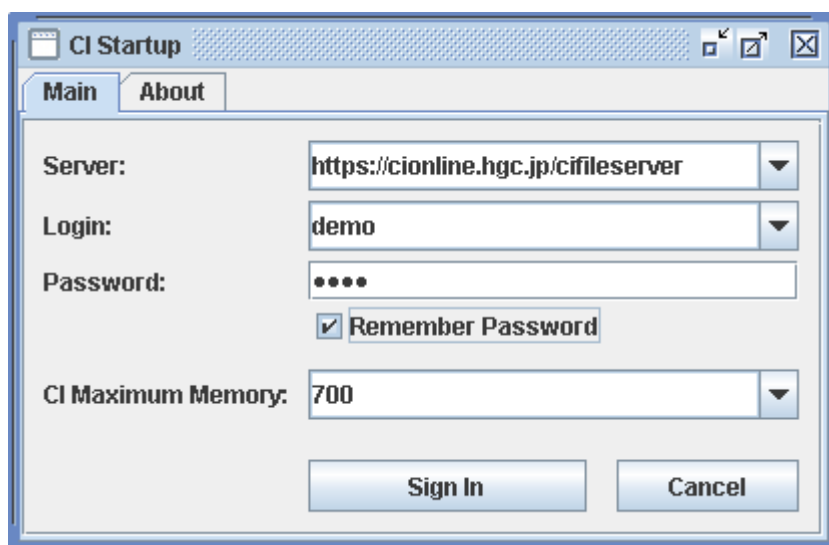

- In the *CI Startup* dialog, enter the login data that you obtained during the registration and press *Sign In*

Note: It is recommended to select the *Remember Password* option. After a successful login, the login and password will be stored on your local computer and you will not need to enter the login data again.

- After this CI Online is downloaded from the server. This may take several minutes.

CI Online is a client-server solution that enables the user to create, manipulate and simulate bio-pathway models locally within CI workspace and to store and organize them on the remote CI Online Server. Additionally CI Online gives the user convenient access to libraries and databases of bio-pathway models.

In CI Online, Cell Illustrator is the front-end, where the user prepares a pathway and simulates it. The Cell Illustrator client communicates with the CI Online Server over the internet (HTTP or HTTPS protocol). The CI Online Server is a place where the user logs-in to store and manage his pathways and to share them with other users.

2.3 Licensing Information

2.3.1 CI Online (CIO)

To run Cell Illustrator, you need to obtain a CI Online account. For details, please contact your local Cell Illustrator reseller.

CI 4.0 offers three license types: *Professional*, *Access* and *Player*. The main differences between the license types are in the simulation capabilities of CI and are briefly summarized in the table below.

License Type	Description
CI Professional	Full version. Includes all simulation and editing/drawing capabilities.
CI Access	Limited version. No simulation capabilities. All editing/drawing capabilities
CI Player	Limited version. Only visualization of models. No simulation capabilities. No editing/drawing capabilities.

Note: This manual describes all functions available in the CI (CI Professional license type). A given function described in this manual might be disabled or not available in the limited versions CI Access and CI Player.

2.4 CI Memory Customization

2.4.1 CI Online

When starting CI Online, you can set the maximum memory for Cell Illustrator in the *Login* dialog box.





3 Cell Illustrator elements







CI is designed to model biological pathways using three types of abstractions: entities, processes and connectors.

3.1 Concept Overview

The modeling and simulation engine of Cell Illustrator™ is based on an extension of the *Petri-net* methodology. A Petri-net models a system of conditions and instantaneous events, their dependencies and mutual synchronization. The *Hybrid Petri-net with extensions* (HFPNe) employed in the Cell Illustrator adds the notion of continuous and generic processes and quantities, which are essential to the description of biological systems [10]. The following table presents a summary of the Petri-net model elements, their explanations and equivalent biological meanings.

Table 1 HFPNe elements.

Hybrid Functional Petri Net Elements		
Petri Net Component	Symbol	Biological Equivalent
<p>Discrete Place A discrete place holds tokens represented as a non negative integer.</p>		<p>Discrete Entity A countable biological component or event that is quantified or represented by an integer, e.g. the number of molecules locating at the membrane, an event that describes whether a protein is binding to DNA or not.</p>
<p>Tokens A token is a unit held in a place.</p>		<p>Quantity The number of entity items present, e.g. the number of molecules binding to DNA, ON/OFF state of a gene expression, etc.</p>
<p>Discrete Transition A discrete transition is a discrete process that consumes tokens from their input places and produces tokens into their output places. The input and output places are connected to a transition by arcs. A transition “fires” and the process is invoked if all the conditions for firing are met. Every transition has a delay time for firing.</p>		<p>Discrete Process A biological reaction that converts quantities in discrete entities into quantities in other discrete entities. A switching mechanism can be also handled as a discrete process which receives some signals and sends out signals for a pathway.</p>
<p>Continuous Place A continuous place holds a non negative real number.</p>		<p>Continuous Entity A biological entity like a concentration of a protein, enzyme, or ion, etc. the quantity of which can be represented as a real number.</p>
<p>Marking A variable representing the state of a place.</p>	m	<p>Concentration, Quantity System status representing quantity or concentration of proteins, enzymes and ions.</p>

<p>Continuous Transition</p> <p>A continuous transition is a continuous process consuming quantities of its input places and producing quantities into its output places. It defines a continuous flow that is specified by a speed of firing [v].</p>		<p>Continuous Process</p> <p>A biological process or a reaction like transcription, translation, or enzymatic reaction, which consumes some entities' (inputs) quantity and produces others (output), according to a rate formula.</p>
<p>Universal Place</p> <p>A universal place can handle a list of variables of various types (double, Boolean, string, etc.).</p>		<p>Generic Entity</p> <p>A biological/chemical/physical entity that is not pre-defined. May contain more data types like string that is used to represent DNA sequence.</p>
<p>Universal transition</p> <p>A transition for a universal place. A universal transition allows the arcs connecting with this transition to use their functions (firing speeds).</p>		<p>Generic Process</p> <p>A complicated biological/chemical/physical process, e.g., a translation process.</p>
<p>Arc/Connector</p>		
<p>Normal Arc</p> <p>A directed arc. Connects a transition to a place or connects a place to a transition. An arc has a weight.</p>		<p>Process Connector</p> <p>Connects input entities to a process and process to output entities. Its weight parameter specifies an activation threshold. Process Connector allows quantities flow in the model.</p>
<p>Inhibitory Arc</p> <p>Connects a place to a transition. An inhibitory arc disables a transition. If the quantity in its source place is greater than the weight of the arc, the transition cannot fire.</p>		<p>Inhibitory Connector</p> <p>Prevents a process from being activated. Inhibitory Connector facilitates the modeling of the inhibition/competition process.</p>
<p>Test Arc</p> <p>Connects a place to a transition. A test arc does not consume any quantity of the source place by firing.</p>		<p>Association Connector</p> <p>Connects entities without causing concentration change. Defines which entities are associated with each other, but not as inputs or outputs. Association Connector allows the modeling of enzymatic reactions as well as other catalytic processes.</p>

3.2 Entities

Entities are abstract elements that can represent any type of biological concepts like mRNAs, DNA, proteins, ligands, and compounds. They can also represent cellular structures like mitochondria, cell nuclei, cells or biological phenomena like transcription and translation.

An entity (Figure 1) contains a value which is interpreted as its quantity or concentration. You can input a more meaningful name and value for the entity. Also, each entity has an associated *variable* (e1, e2, e3) representing its quantity (30, 123.2, ATGC, respectively). The mathematical equations used for simulation are expressed in terms of these variables.

There are three types of entities: *discrete entity*, *continuous entity* and *generic entity*.

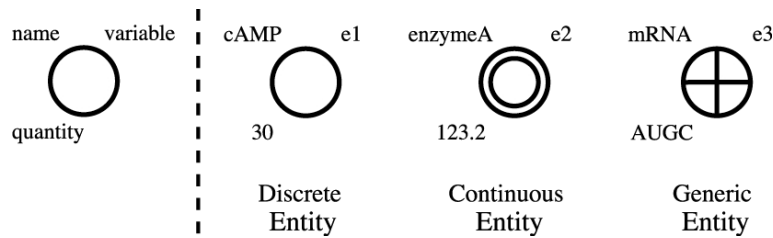

Figure 1

Discrete entity holds an integer quantity (Integer or Long). In contrast, a continuous entity has a continuous (e.g. real / fractional) number as its quantity (Double). This type of entity is used to represent concentrations, e.g. the number of ions or enzymes. Other type of entity is a generic entity. It holds string or logical value (String or Boolean).

3.3 Connectors

Connectors are used to connect entities to processes (*input connectors*) or processes to entities (*output connectors*).

There are three types of connectors (Figure 2): *process connectors*, *inhibitory connectors* and *association connectors*. An input connector can take all three types. In contrast, an output connector is always of the process type. Correspondingly, all types of connectors can connect input entities to a process. In contrast, only a process connector can connect a process to an output entity.

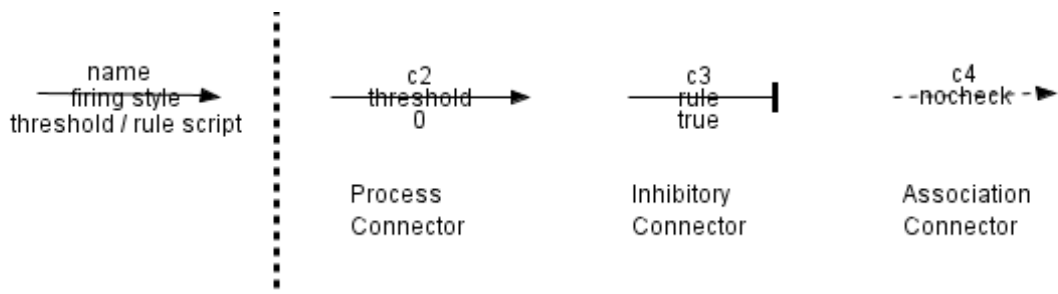

Figure 2

The *threshold* is an input connector's parameter. It can be a value or a script, e.g. $m/10$. This parameter is used to define the minimum value of the input entities needed for the activation or deactivation of the linking processes.

A process and an association connector become *activated* if the threshold of the connector is smaller than the value of input entity. On the other hand, inhibitory connectors are activated when input entity is less than this threshold. Inhibitory connectors are used to model repression (see Section 4.9). Association connectors are used to model the situation when entities and processes need to be linked together, but nothing is produced or consumed. They do not allow transport of quantities. They are used when the input entities concentrations do not change (see Section 4.10).

3.4 Processes

Processes (**Figure 3**) define the rate of entity value changes and interactions among entities. Processes are used to model biological reactions such as enzymatic reactions or protein complex formation processes. Processes can take multiple inputs (e.g. consume different entities to produce new entities) and have multiple outputs (e.g. produce different entities, such as breaking down sacharose into glucose and fructose). Also, like entities, processes can be continuous (*continuous processes*), discrete (*discrete processes*) or generic (*generic processes*), depending on the input, output and timing. Only generic processes are able to handle generic entities.

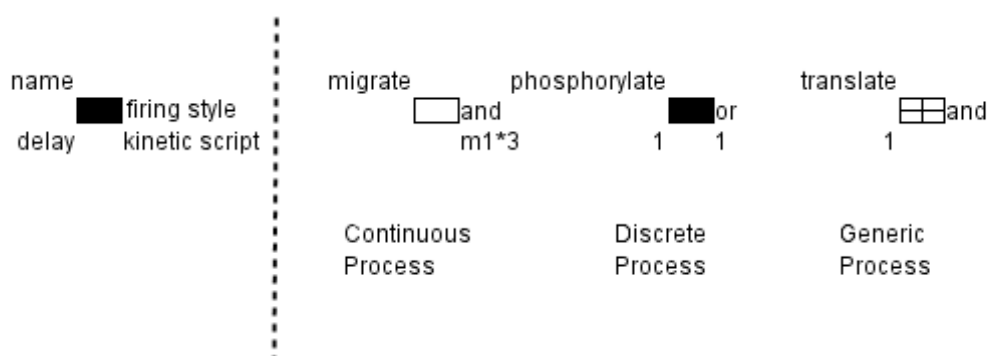

Figure 3

In general terms, if all input connectors of a process are activated the process is said to be *enabled* (see Section 6.1). When a process is enabled, the reaction that it represents will *fire* (will be executed) immediately or after a certain time interval. This will cause a change in value for all connected entities. For example, if a process represents the reaction of a protein precursor which turns into an activated protein by phosphorylation, the decrease of the precursor protein and the increase of the active protein on account of the speed of phosphorylation is simulated once the process fires. The exact conditions for enabling a process depend on its Firing Style parameter and are described in detail, along with other process parameters, in Section 5.4.2.

The process type determines its *calculation style*. The continuous process has the *speed* calculation style - the process calculates the speed of production or consumption of the entities. On the other hand, the discrete process has the *add* style - the process calculates the concrete values that should be added/subtracted to the entities. Finally, the calculation style of the generic process is *update*, i.e., the process calculates a concrete value that will replace the entity value. The Kinetic Script parameter specifies how to calculate the value change of connected entities in each of the three cases. See the Reference Manual for details.

Each discrete and generic process has an additional Delay parameter that can be a constant or a function. The firing of a discrete process occurs abruptly with the delay associated with the process. The same applies to generic processes. The activity of continuous processes is different: The firing of a continuous process occurs continuously. Consequently, a continuous process does not hold the Delay parameter.



To employ generic processes one must use the Pnuts scripting language. Use of Pnuts is briefly described in Section 5.6.

Another important parameter associated with a process is its Kinetic Style. If the process kinetic style is Custom then the value change after the process fires is the same for all connected input/output entities. For all other kinetic styles, the value change at each entity depends on connector-specific parameters such as Connector Stoichiometry and Connector Speed. Thus, it may be different for different input/output entities.

3.5 Element Combinations

All combinations of discrete and continuous CI elements are presented in Table 2 and Table 3.

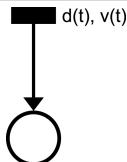
Table 2 Output Connectors

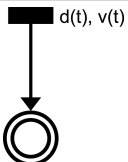
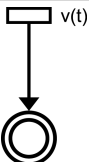
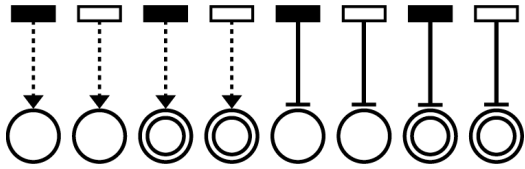
 <p>Transport quantity $v(t)$ through the Connector at $d(t)$ intervals.</p>	 <p>Not Allowed.</p>	 <p>Transport quantity $v(t)$ through the Connector at each $d(t)$ interval.</p>	 <p>Sequentially transport quantity $v(t)$ through the Connector.</p>
 <p>Not Allowed.</p>			

The variable $m(t)$ represents quantity or concentration of the entity at time t . The variable $w(t)$ is the threshold of the corresponding connector. The constant $d(t)$ is the delay time of the corresponding process and the function $v(t)$ is the speed of the corresponding process at the time t . Note that CI checks and prohibits the connections that are not allowed during model creation.

Table 3 Input Connectors

<p>Process is enabled at intervals of the time $d(t)$ while $m(t) > w(t)$ holds.</p>	<p>Not Allowed</p>	<p>Process is enabled at intervals of the time $d(t)$ while $m(t) > w(t)$ holds.</p>	<p>Process is enabled at the speed of $v(t)$ while $m(t) > w(t)$ holds.</p>
<p>Process is enabled at intervals of the time $d(t)$ while $m(t) > w(t)$ holds, but no quantity change.</p>	<p>Process is enabled while $m(t) > w(t)$ holds, but no quantity change.</p>	<p>Process is enabled at intervals of the time $d(t)$ while $m(t) > w(t)$ holds, but no quantity change.</p>	<p>Process is enabled while $m(t) > w(t)$ holds, but no quantity change.</p>
<p>Process is not enabled while $m(t) > w(t)$ holds.</p>	<p>Process is not enabled while $m(t) > w(t)$ holds.</p>	<p>Process is not enabled while $m(t) > w(t)$ holds.</p>	<p>Process is not enabled while $m(t) > w(t)$ holds.</p>

3.6 Discrete Elements Example 1

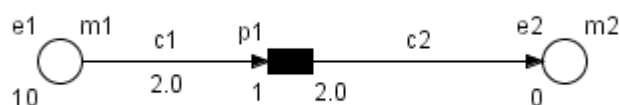

Figure 4

The model in Figure 4 consists of two discrete entities e1 and e2, and the discrete process p1 between them. The entity e1 is connected to p1 with the input process connector c1. The process p1 is connected to e2 with the output connector c2. The kinetic style of the process is Custom. The entities e1 and e2 have the initial value 10 and 0, respectively. The input connector c1 has the Threshold parameter equal 1. The threshold of an input connector controls the activity of process p1. The process p1 has the delay parameter equal 1 and the add parameter equal 2. This model can be used for auto catalytic reactions, e.g. protein auto-phosphorylation.

In the HFPNe theory, time is measured in virtual time units called Petri net time (**pt**). At time 0, the value of e1 is 10 and the threshold of c1 is 2, and the process p1 is enabled. When all input processes are enabled, the connected discrete process is really executed after the delay time of the process. In this example, the delay parameter of the process p1 is 1. Therefore, the process is executed at time 1.

Consequently, at time 1 the entity e1 decreases and e2 increases by the speed of process p1, i.e., 2. Thus, at time 1, the value of entity e1 and e2 becomes 8 and 2, respectively.

At time 4, the value of the entity e1 becomes 2 and the process p1 cannot be enabled because the value of e1 is less or equal than the threshold of c1. At that time, the process p1 cannot be enabled and e1 and e2 reach a stable state. The results of the simulation are presented below (Figure 5).

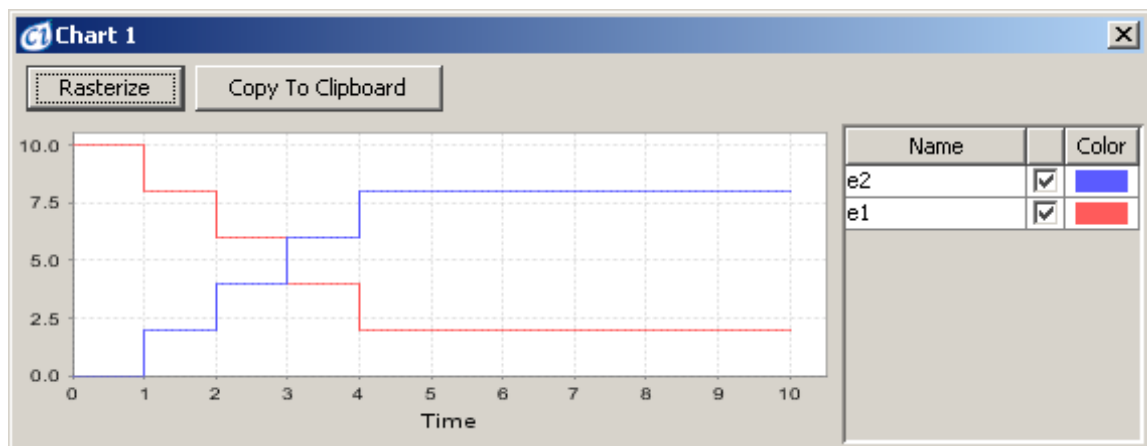

Figure 5

3.7 Discrete Elements Example 2: Connector Speed

In the previous model, the values of e1 and e2 increase and decrease by the same amount (2) at each time interval because their value depends on the add value of the process p1. However, modeling differing increase and decrease in the value of connected entities is sometimes necessary, e.g., when a monomer becomes a dimer or a trimer and vice versa.

To deal with this type of process, set the process kinetic style to *connector custom* and then define the value changes of the connected entities separately.

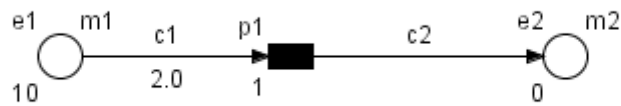

Figure 6

The example in Figure 6 demonstrates the use of the connector custom kinetic style. The difference between the previous example and the model in Figure 6 is as follows:

- (i) The add parameters of connector c1 and c2 are 2 and 1, respectively.

At time 0, the value of e1 is 10 and the threshold of c1 is 1 and the process p1 is enabled. After the delay of p1, i.e. 1, the process is executed. The add value of c1 and c2 are 2 and 1, respectively. Thus, the value of e1 and e2 becomes 8 and 1 at time 1, respectively. At time 4, the value of e1 and e2 are 2 and 4, respectively. At that time, the process p1 is not enabled and e1 and e2 reach a stable state. The results of the simulation are presented below (Figure 7).

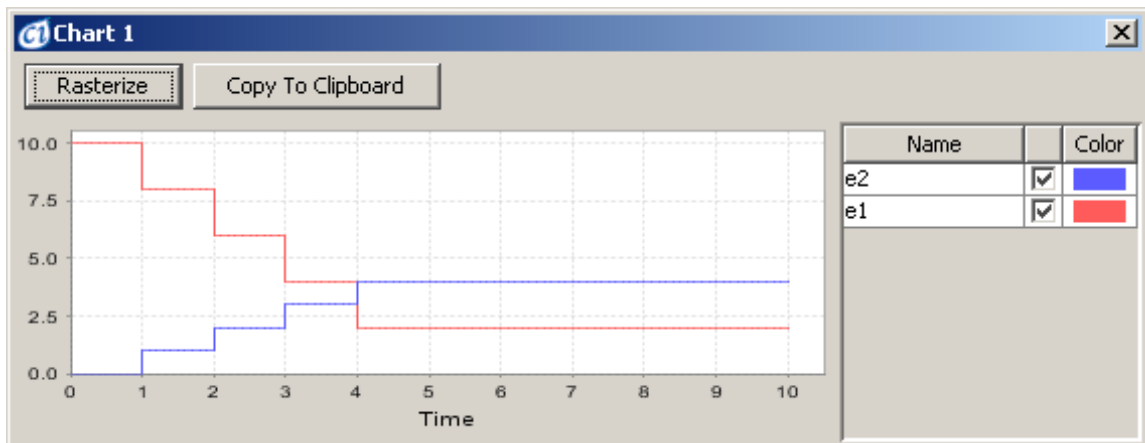

Figure 7

3.8 Continuous Elements Example 1

In the previous two examples, discrete entities and discrete processes have been used. However, in many cases, entity values should be treated as continuous variables rather than discrete variables. The model in Figure 8 has been created by conversion of the discrete model in Section 3.6.

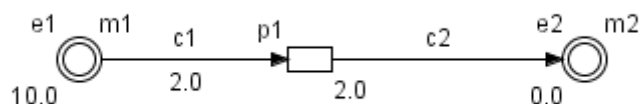

Figure 8

More specifically, the differences between the models in Figure 4 and in Figure 8 are as follows:

Step 1: The type of entities e1 and e2 is changed from discrete to continuous.

Step 2: The type of process p1 is changed from discrete to continuous.

All other parameters are the same as in the discrete model in Section 3.6. Note that the Delay parameter of p1 has no meaning now, since it is not applicable to a continuous process. For the continuous processes the delay parameter is always zero.

As described in Section 3.6, the threshold parameter of the input connector works like the threshold of the activity of process p1. In this example, at time 0, the value of e1 is 10 and the threshold of c1 is 2 and the process is enabled. When all input connectors are enabled, the connected continuous process is executed with no delay.

Since p1 is connected to e1 with the quantity m1, and its output is connected to e2 with the quantity m2, the equations for quantities change are:

$$-\frac{dm1}{dt} = \frac{dm2}{dt} = 1$$

At time 4, the value of e1 is the same as the threshold of c1, i.e. 2. At that time, the process p1 cannot be enabled and e1 and e2 reach a stable state. The results of the simulation are presented below (Figure 9).

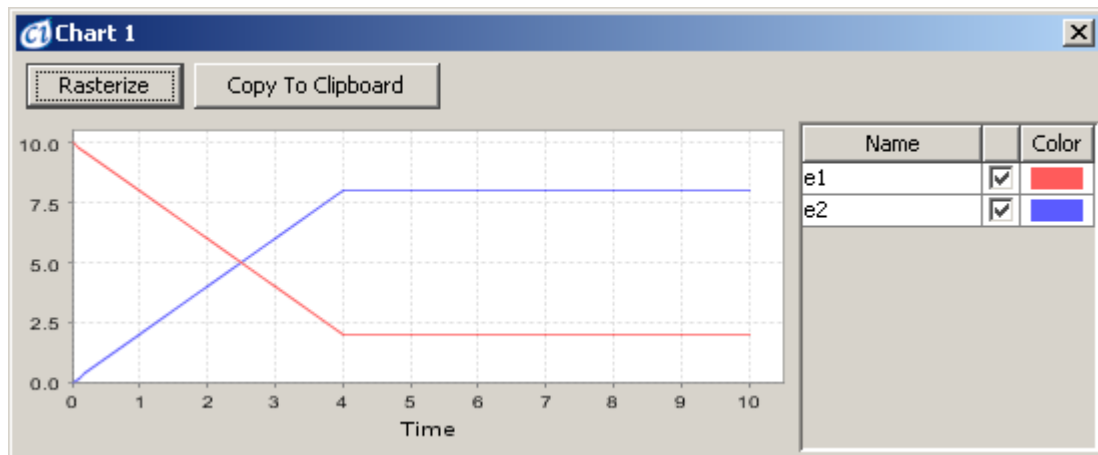

Figure 9

The same conversion process can be applied to the discrete model in Section 3.7 (Figure 10).

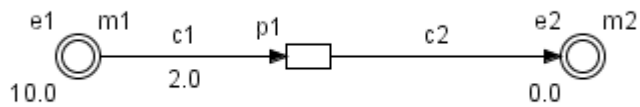

Figure 10

The equations for quantity changes are:

$$-\frac{dm1}{dt} = 2, \frac{dm2}{dt} = 1$$

The results of the simulation are presented below (Figure 11).

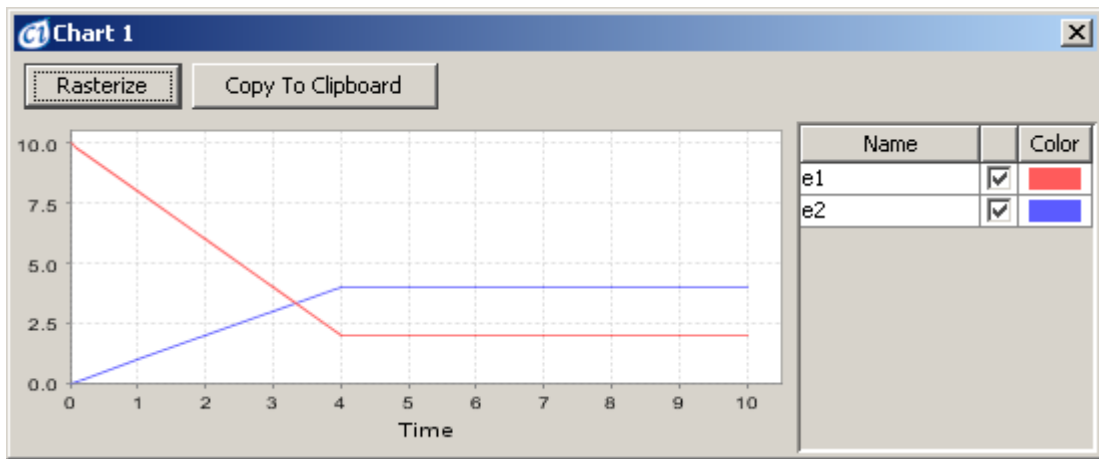

Figure 11

3.9 Continuous Elements Example 2

In the previous two examples, discrete examples were converted into similar models with continuous elements. For kinetic based modeling, one should use a continuous model rather than a discrete one.

In the following model (Figure 12), the consumption ratio of e1 is proportional to the value of e1, i.e. the speed of process p1 follows the mass action kinetics.

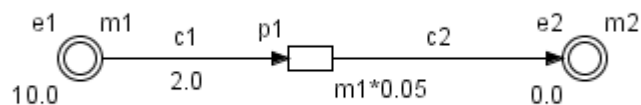

Figure 12

The difference between the present model and the model in Section 3.8 is that the speed of p1 is changed from 1 to $0.05 * m1$. In this model, process p1 continuously transports entity e1 to e2 at the rate of $1/20$ of e1's concentration $m1$. Since p1 is connected to e1 with quantity represented by $m1$, and its output is connected to e2 with quantity $m2$, the equations for quantities change are:

$$-\frac{dm1}{dt} = \frac{dm2}{dt} = 0.05 * m1$$

The value of entity e1, i.e. $m1$, decreases while the value of entity e2, i.e. $m2$, increases during simulation. The equation ($0.05 * m1$) of process p1 governs this change of value per unit time (see Section 6.1 for Simulation Details).

The results of the simulation are presented below (Figure 13).

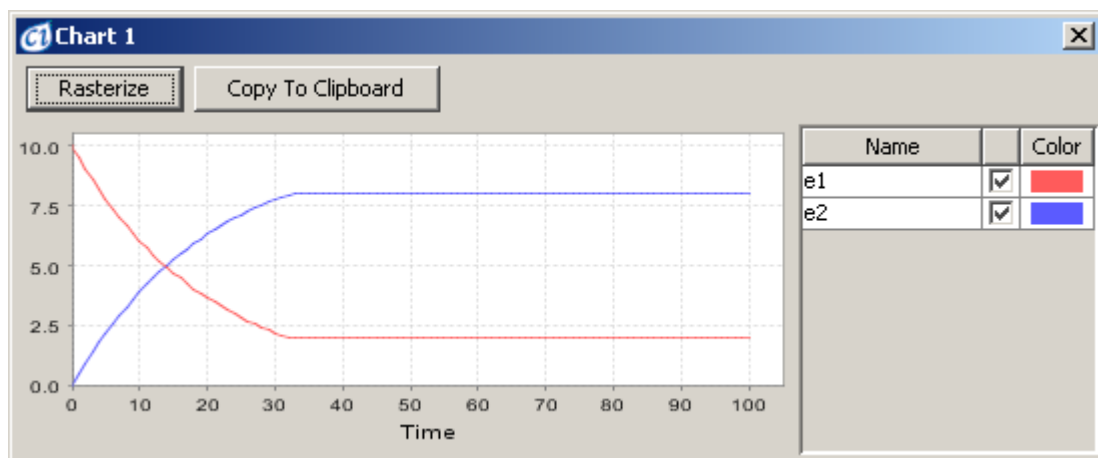

Figure 13

If consumption and generation speed should be different, the Connector Custom kinetic style should be used and the corresponding speed/add parameters for connectors c1 and c2 should be set. In Figure 14, the speed of c1 and c2 is $0.05 * m1$ and $0.1 * m1$, respectively.

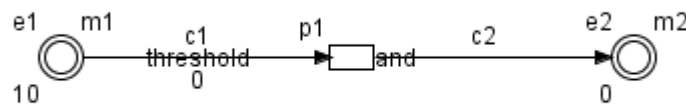

Figure 14

The results of the simulation are presented below (Figure 15).

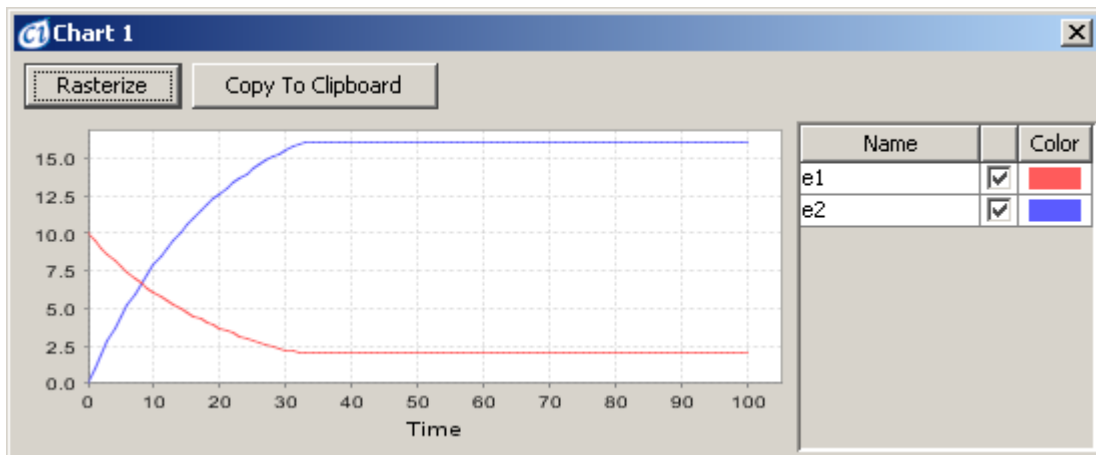

Figure 15

4 Biological Process Modeling with Cell Illustrator

This section briefly explains how to simulate major biological processes with CI. The examples have been designed to help the novice user to become familiar with the Hybrid Petri Net modeling method and notation.

4.1 Degradation

In a cell, nearly all mRNAs and proteins fragment into parts at certain speeds. This fragmentation activity is called degradation. A model of degradation can be created with the following steps.

Step1: Create an entity and change its name, e.g. p53, and set its value, e.g. 100.

Step2: Create a process and set its name, e.g. “degradation”.

Step3: Connect the p53 entity to the degradation process with the process connector.

Step4: Set the degradation speed by editing the speed parameter of the degradation process (the default speed is 1.0).

In Step1 and Step2, a discrete entity and a discrete process, a continuous entity and a continuous process, a continuous entity and discrete process combinations are possible (Figure 16).

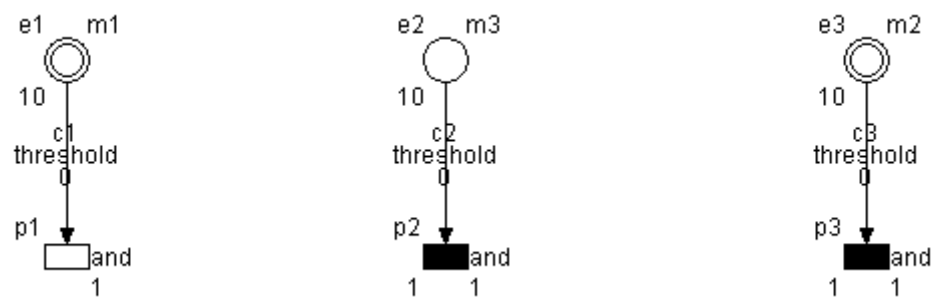

Figure 16

The results of the simulation are presented below (Figure 17).

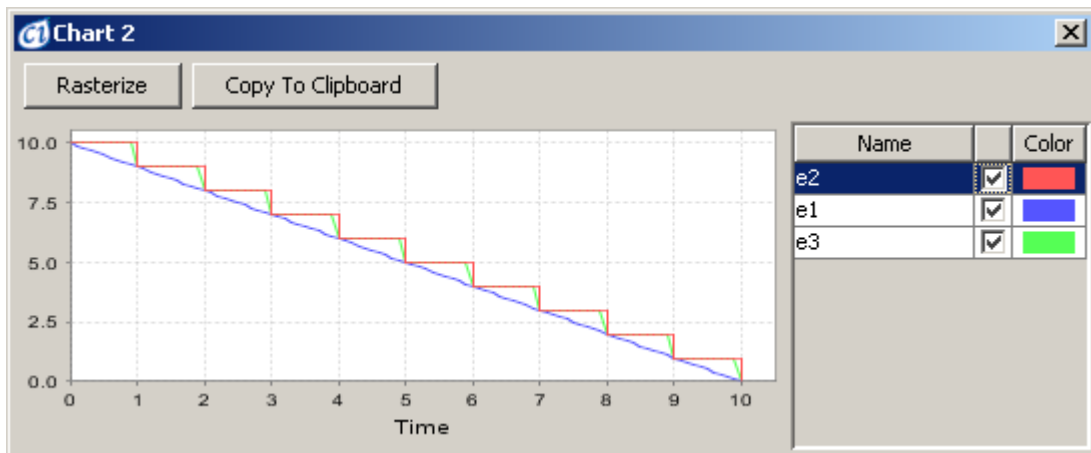

Figure 17

If the degradation speed depends on the value of p53 protein (say m), in Step 4 the speed should be made dependent on m (Figure 18).

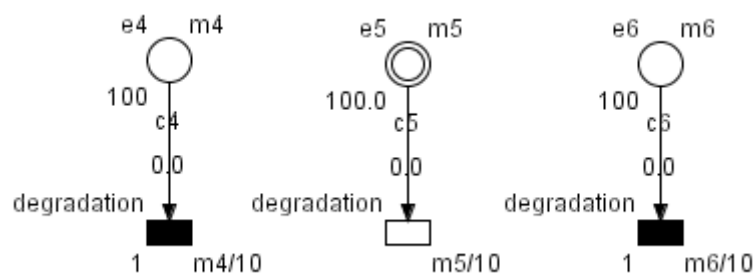

Figure 18

The results of the simulation are presented below (Figure 19).

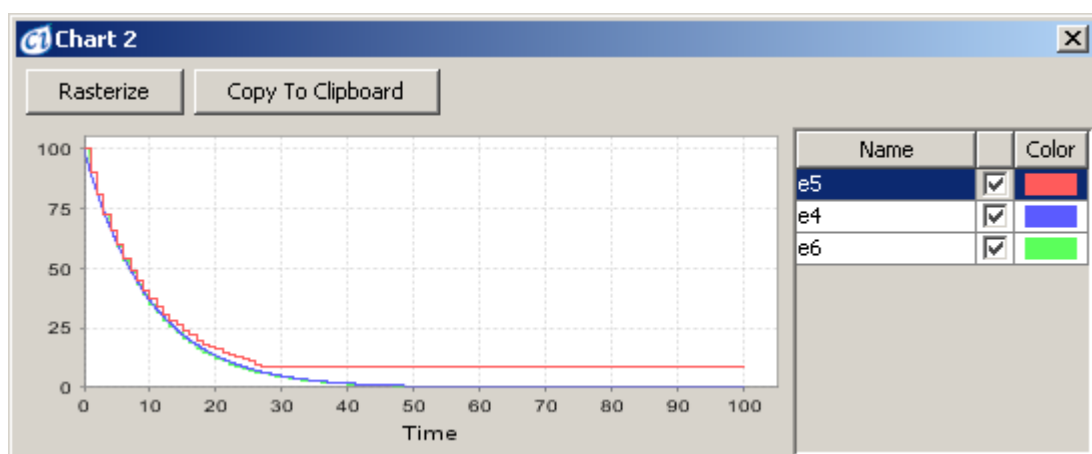

Figure 19

4.2 Translocation

In a cell, mRNA and proteins move from one compartment to others, e.g. from nuclei to cytoplasm and vice versa. A model for this can be created with the following steps.

Step1: Create two entities and change their names, e.g. p53_nuclei and p53_cytoplasm and set their values, e.g. 100 and 0.

Step2: Create a process and set its name, e.g. translocation. Connect the p53_nuclei to the process and connect the process to p53_cytoplasm.

Step3: Set the translocation speed by editing the Speed/Add option of the translocation process (the default speed is 1.0).

In Step1 and Step2, possible combinations of (p53_nuclei, translocation, p53_cytoplasm) triple are (discrete, discrete, discrete), (discrete, discrete, continuous), (continuous, discrete, continuous), (continuous, discrete, discrete) and (continuous, continuous, continuous) (Figure 20).

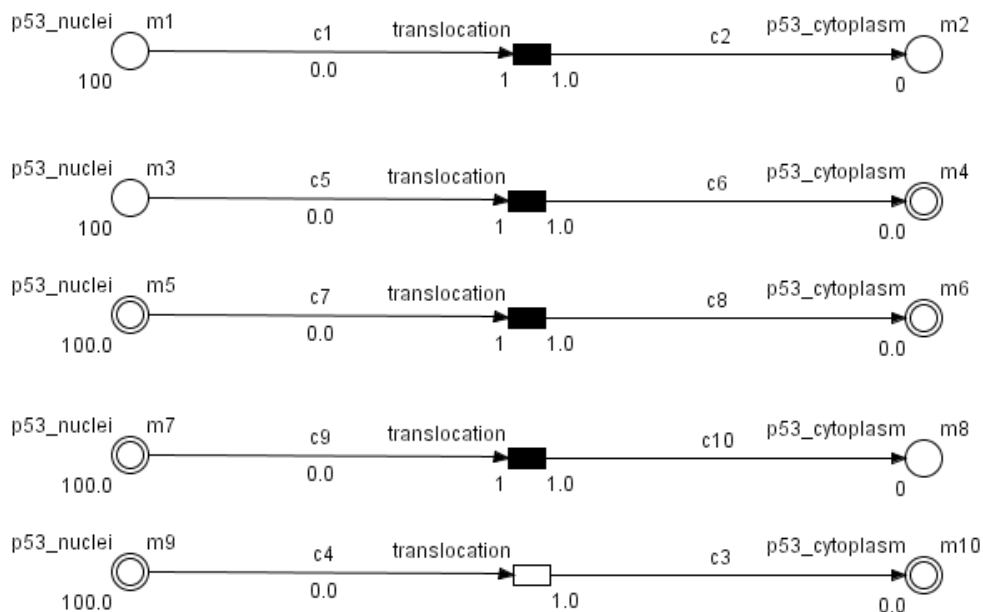

Figure 20

The simulation results of the discrete model are presented below (Figure 21).

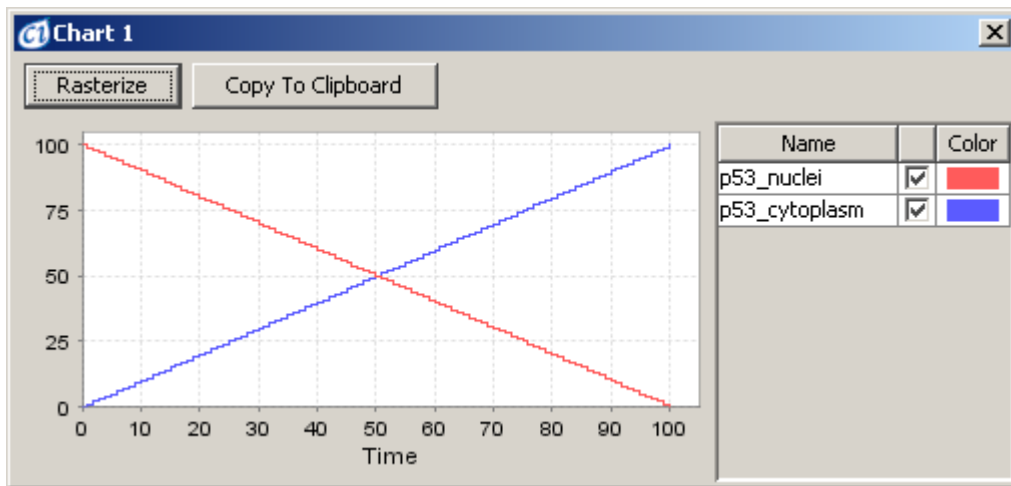

Figure 21

If the translocation speed depends on the quantity of p53_nuclei (say m_1), as in the degradation example, Section 4.1, the process speed should be made dependent on $m_1/10$ in Step3. (The factor of $1/10$ was used in the example in Figure 22.)



Figure 22

The results of the simulation are presented below (Figure 23).

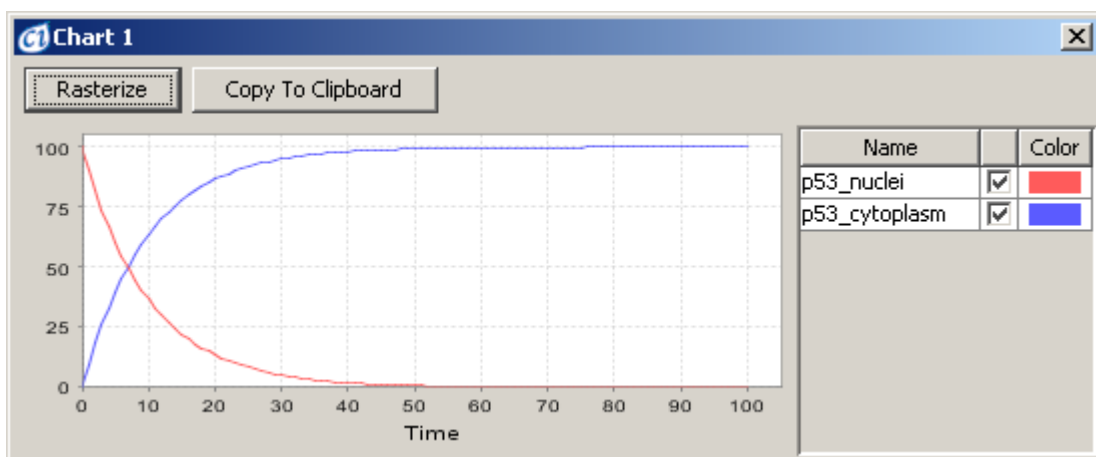

Figure 23

4.3 Transcription

Transcription modeling can easily be done using CI. A model can be created with the following steps.

Step1: Create a process and set its name, e.g. transcription.

Step2: Create an entity and change its name, e.g. mRNA_p53.

Step3: Connect the transcription process to mRNA_p53 entity with the process connector.

Step4: Set the transcription speed by editing the Speed/Add option of the transcription process.

In Step1 and Step2, possible combinations of the pair (transcription, mRNA_p53) are (discrete, discrete), (discrete, continuous) and (continuous, continuous) (Figure 24).

Cell Illustrator facilitates the modeling of the path DNA \rightarrow mRNA \rightarrow Protein not only as a concentration function of DNA, mRNA and Protein. Global transcription and translation mechanism can be established with a string input (DNA sequence), intermediate product (proper mRNA) and product (Protein). This mechanism can produce simultaneously many proteins from different DNA sequences.

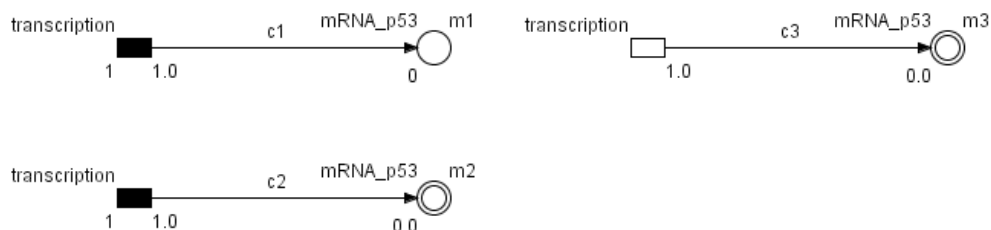

Figure 24

The simulation results of the discrete model the are presented below (Figure 25).

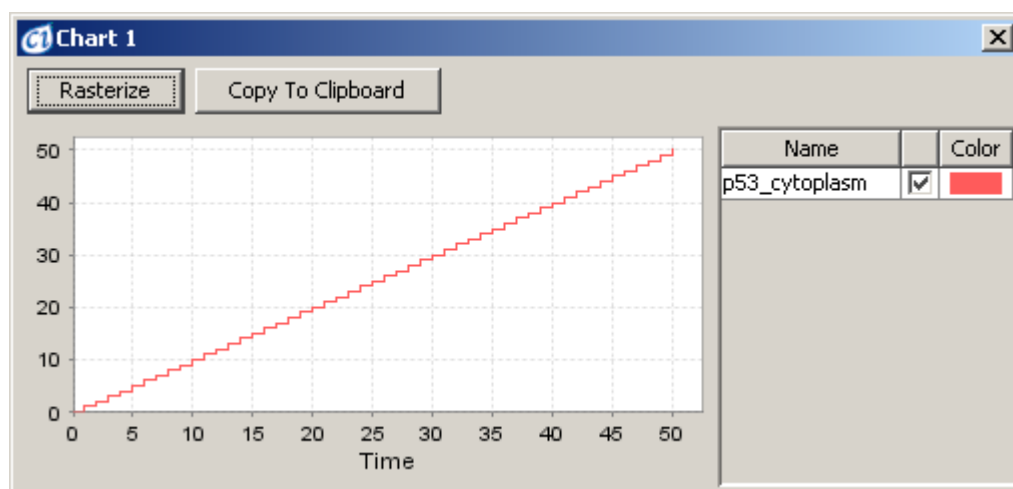

Figure 25

Normally, mRNA synthesis is associated with its degradation. The models presented below (Figure 26) combine the transcription process with the degradation process in Section 4.1 (The same speed $m/10$ is applied.)

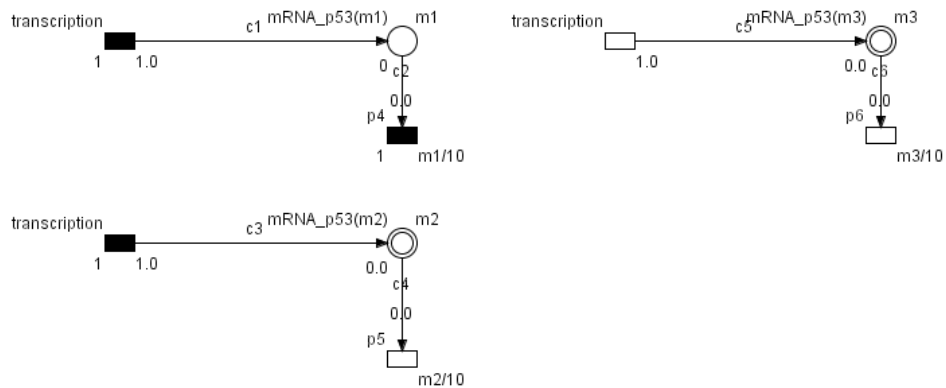

Figure 26

The results of the simulation are presented below (Figure 27).

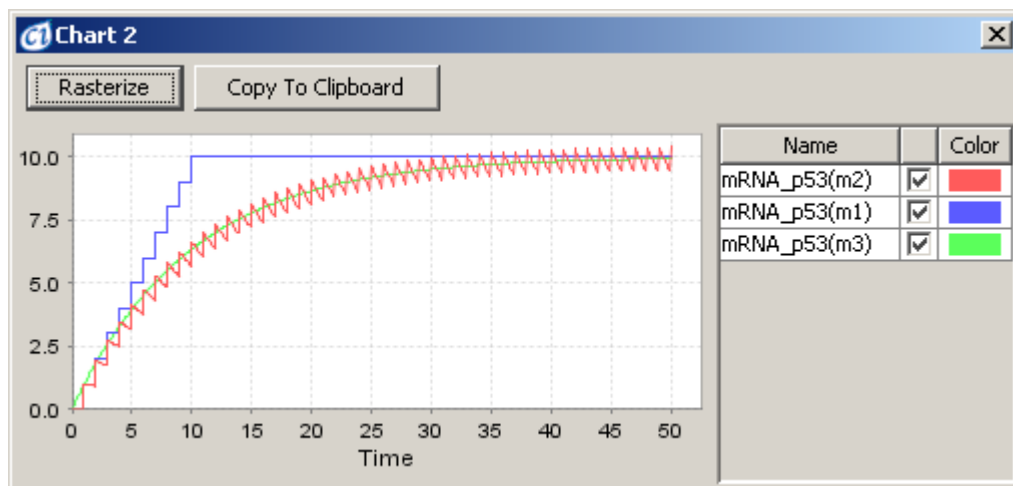

Figure 27

4.4 Complex

In a cell, a set of proteins binds and creates a complex. A model for this can be created with the following steps.

Step1: Create three entities and set their names, e.g. p53, mdm2, p53_mdm2, and set their values, e.g. 100, 50, 0.

Step2: Create one process and changes its name, e.g. complex.

Step3: Connect p53 entity and mdm2 entity to the complex process. Connect the combine process to the p53_mdm2 entity.

Step4: Set the combine speed by editing Speed/Add options of the complex process (the default value is 1.0).

In Step1 and Step2, 9 combinations of element types in the pattern (p53, mdm2, p53_mdm2, complex process) are allowable, i.e., (discrete or continuous, discrete or continuous, discrete or continuous, discrete) and (continuous, continuous, continuous, continuous) (Figure 28).

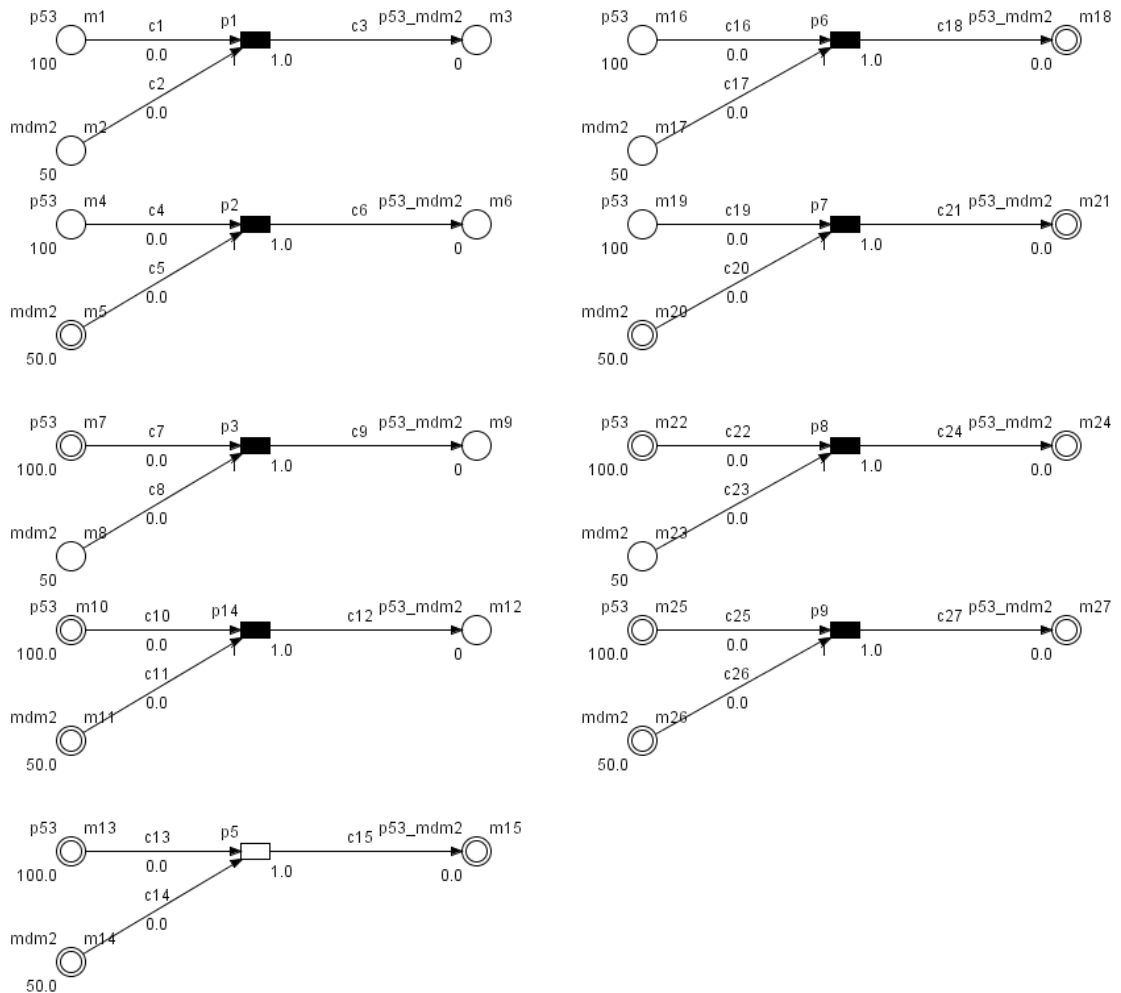

Figure 28

The simulation results of the continuous model are presented below (Figure 29).

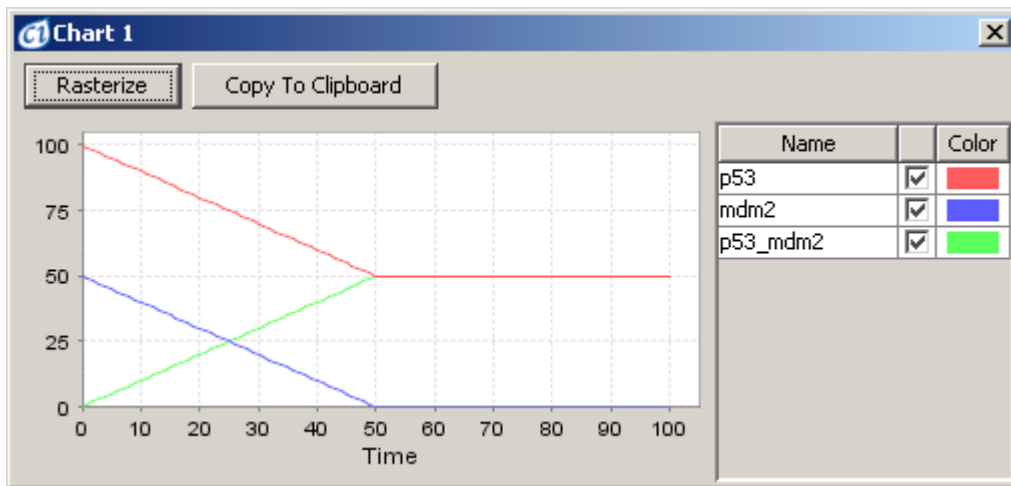

Figure 29

If the complex speed strictly depends on the value of p53 (m_1) and mdm2 (m_2), the speed of the complex process needs to be $(m_1 * m_2) / 400$ (the factor $1/400$ is an example) for the model where all elements are of the continuous type as in Figure 30.

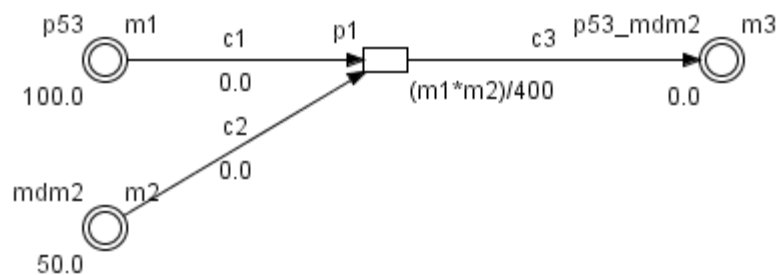

Figure 30

The results of the simulation are presented below (Figure 31).

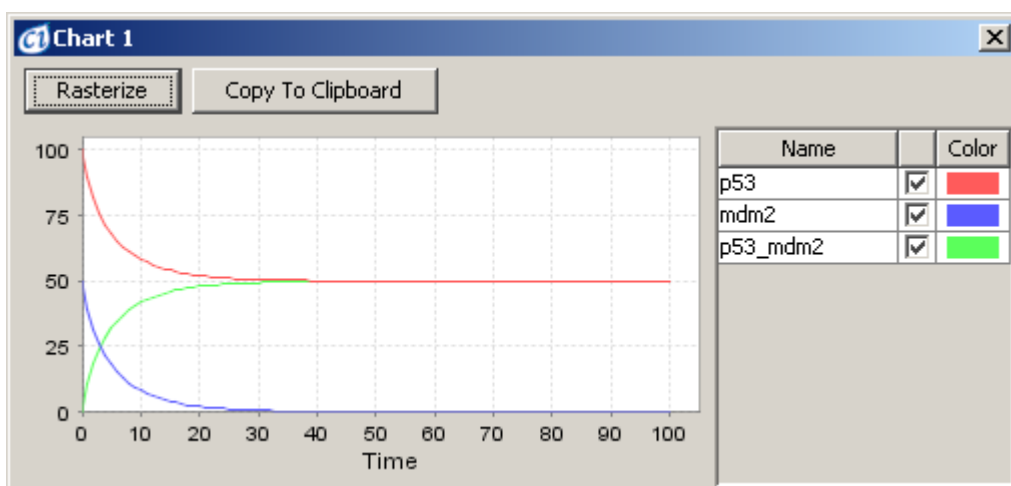

Figure 31

4.5 Tetramerization

In a cell, some proteins create a self-complex under certain conditions. For example, p53 can create a homotetramer. The process of creating tetramers is called tetramerization. The three examples below show how various *kinetic styles* processes can be used for the modeling of tetramerization. The speed of tetramerization is linearly dependent on the mass of monomers in the first example. In the second example, stochastic perturbation is introduced. Finally, in the most advanced example, tetramerization is defined by a script.

A simple model of tetramerization can be created using the following steps:

Step 1: Create two entities and set their names, e.g. p53 (monomer) and p53 (tetramer). Set the initial value of the monomer to 10.

Step 2: Create a process and set its name, e.g. “tetramerization”.

Step 3: Connect the p53 (monomer) entity to the process with a process connector.

Step 4: Connect the process to the p53 (tetramer) entity with a process connector.

Step 5: Change the Kinetic Style of the process to Mass and set “c1 Stoichiometry” to 4. Leave the default values for the other parameters of the process: Coefficient1 - 0.01, Coefficient2 - 0.1 and “c2 Stoichiometry” - 1.

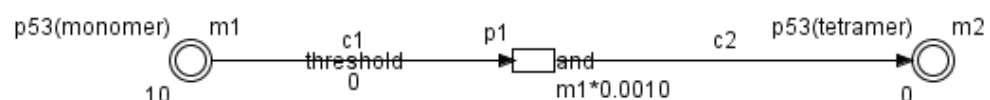

Figure 32

With the model, as in Figure 32, the speed of the tetramerization process depends on the value of p53 (tetramer). To make the process of tetramerization faster the Coefficient1 value should be increased. To change tetramerization into the dimerization process the “c1 stoichiometry” value should be changed to 2. More details on parameters related to the Mass kinetic style can be found in [the section . 3.4 Processes](#).

The results of the simulation are presented below (Figure 33).

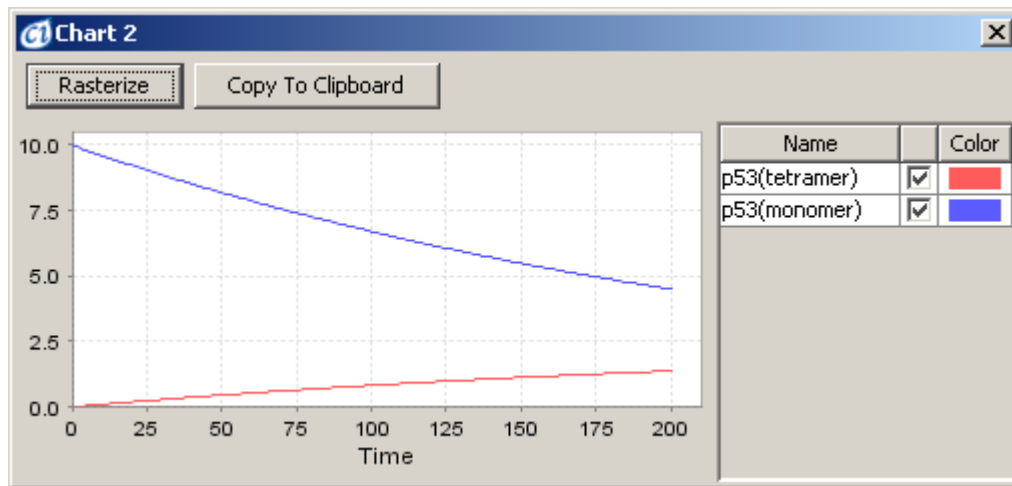

Figure 33

4.6 Stochastic Tetramerization

Normal biological processes (e.g. dimerization or tetramerization) are not deterministic but stochastic. To improve modeling of the biological processes one can use the Stochastic Mass kinetic style of the process. Starting from the previous model, the stochastic tetramerization process can be modeled as follows:

Step 6: Change the Kinetic Style of the process to Stochastic Mass. Set the Standard Deviation to 0.2. This parameter controls the distribution of the randomly generated process speed.

Step 7: Make sure that other parameters are the same as in the previous Tetramerization example, i.e. “c1 Stoichiometry” is 4.

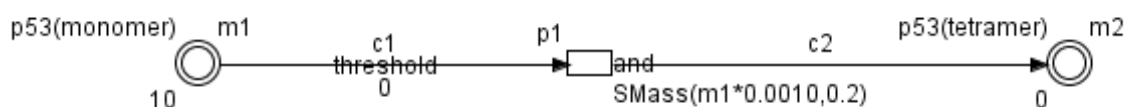

Figure 34

In the model, shown in Figure 34, the speed of the tetramerization process represents stochastic behavior. Parameters related to Stochastic Mass kinetic style are described in [section 3.4 Processes](#).

The example results of the simulation are presented below (Figure 35). Note that subsequent simulation runs will give different results due to the stochastic nature of the model.

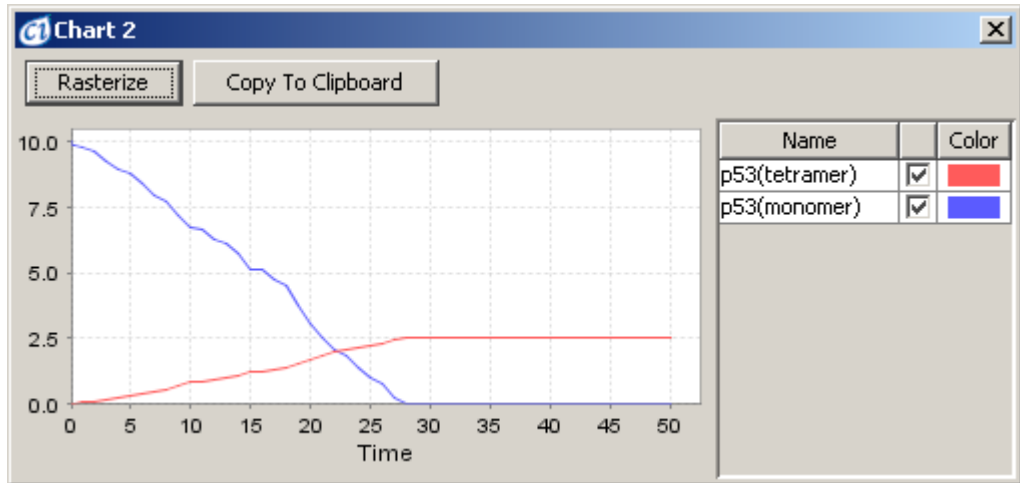

Figure 35

4.7 Custom Tetramerization

Tetramerization can also be defined by a custom formula: In the example in Section 4.5, the process speed depends on the p53 (monomer) in a linear way, but one can change it into a quadratic function by writing a script. The example in 4.5 could be modified as follows:

Step 6: Change the Kinetic Style of the process to Connector Rate and set the Rate parameter as $0.001 * m1 * m1$.

Step 7: Make sure that other parameters are the same as in the previous Tetramerization example, i.e. “c1 Stoichiometry” is 4.

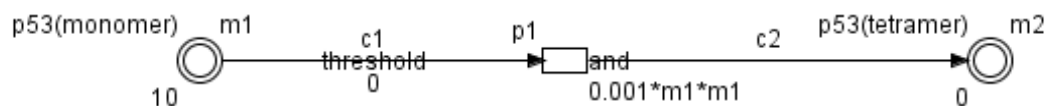

Figure 36

In the model in Figure 36, the speed of the tetramerization process is proportional to the square of p53 (monomer).

The results of the simulation are presented below (Figure 37).

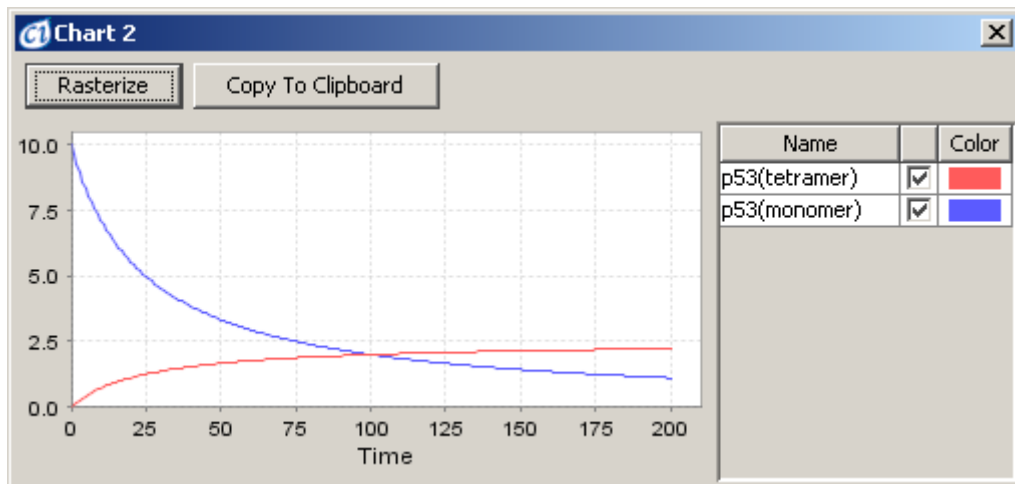

Figure 37

4.8 Separation

In a cell, binding proteins are sometimes separated with proteins. A model can be created here with the following steps:

Step1: Create three entities and set their names, e.g. p53, mdm2, p53_mdm2, and set their value, e.g. 50, 0, 50.

Step2: Create one process and set its name, e.g. separate.

Step3: Connect the p53_mdm2 entity to the separate process. Connect the separate process to the p53 entity and the mdm2 entity.

Step4: Set the separate speed by editing the speed / add options of the separate process (the default value is 1.0).

Again, 9 combinations of element types in the set (p53, mdm2, p53_mdm2, separate process) are possible in Step1 and Step2, i.e. (discrete or continuous, discrete or continuous, discrete or continuous, discrete) and (continuous, continuous, continuous, continuous) as in Figure 38.

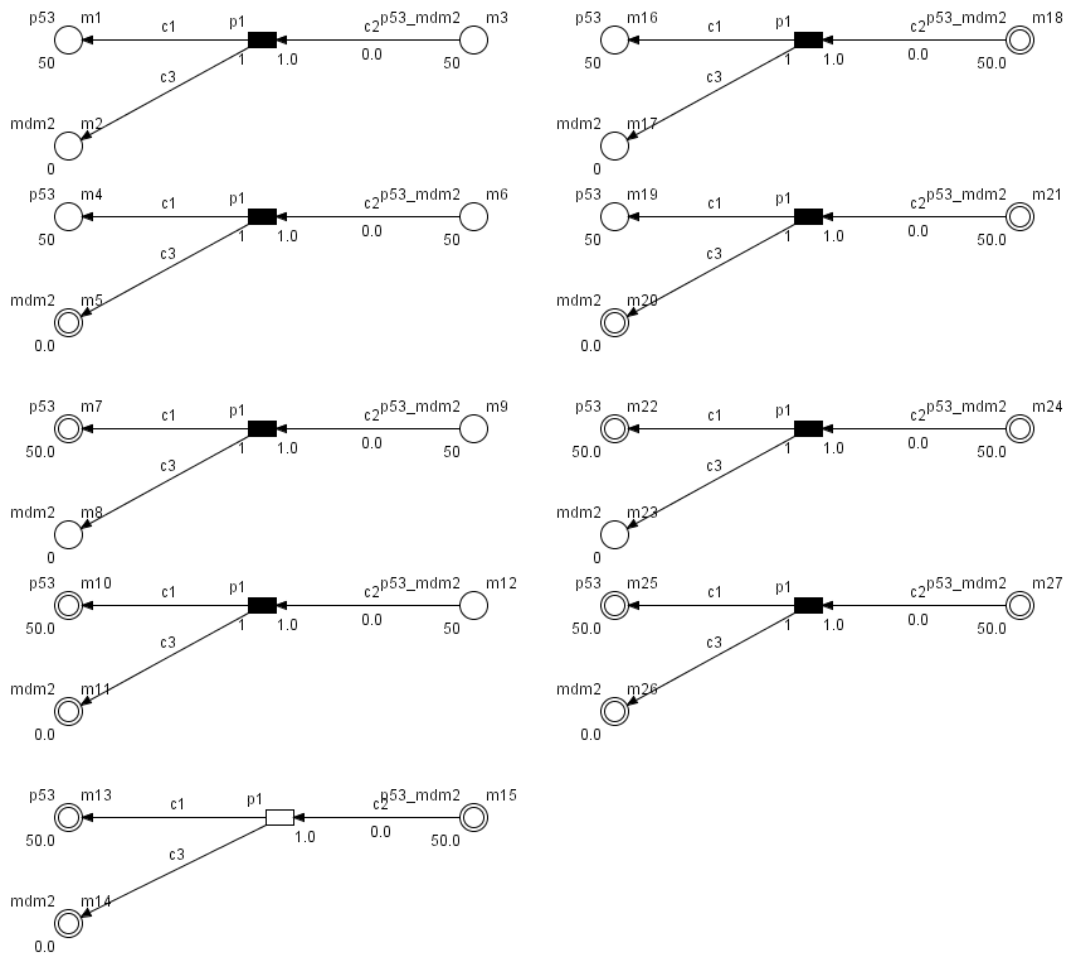

Figure 38

The results of the simulation are presented below (Figure 39).

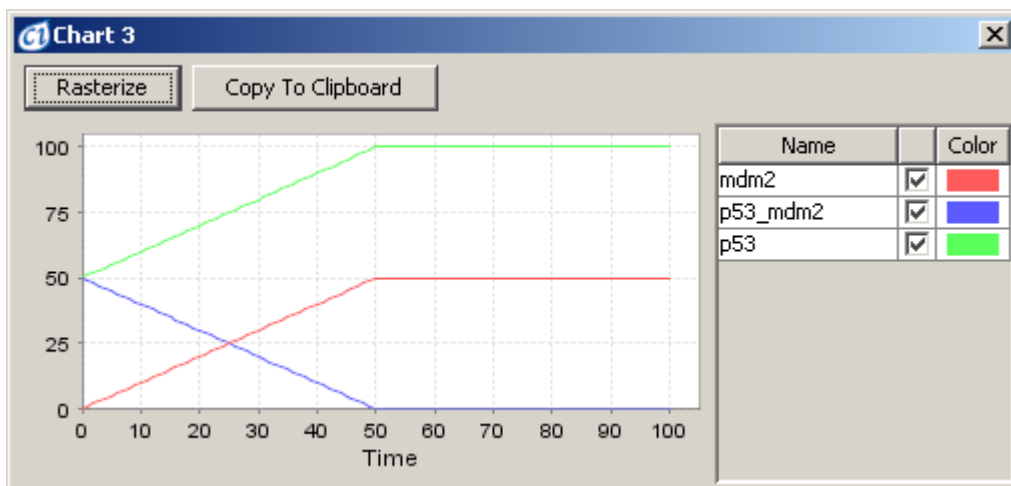

Figure 39

If the speed of the separate process strictly depends on the value of p53_mdm2 (say m1), this can be expressed by a respective equation defining the speed parameter of the process (In Figure 40, $m3/20$ for the model where all elements are of the continuous type).

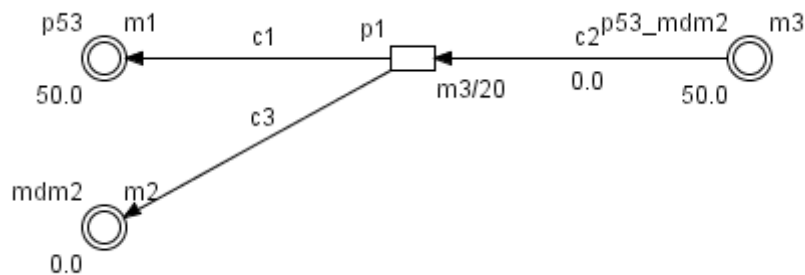

Figure 40

The results of the simulation are presented below (Figure 41).

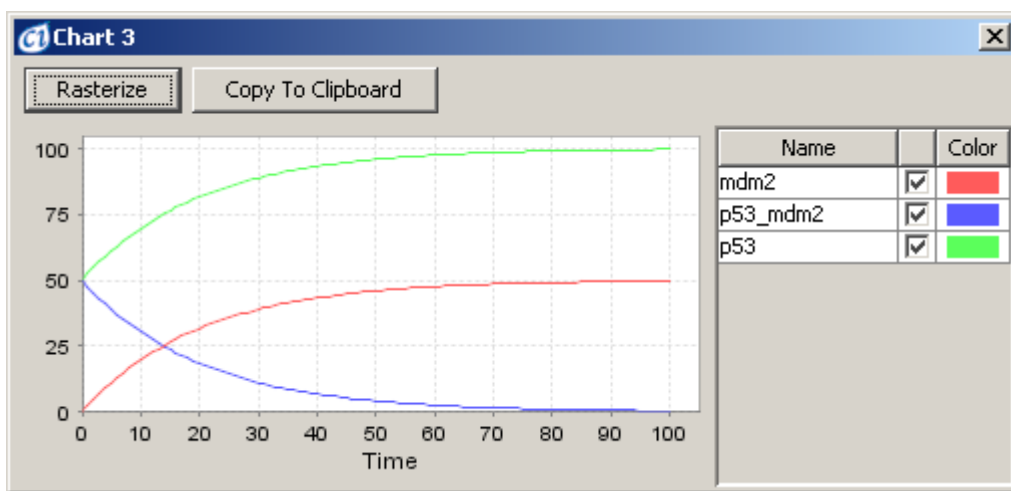

Figure 41

For models based on discrete elements, it is difficult to create a model that fulfills this condition.

4.9 Inhibition

A specific drug sometimes inhibits activities of transcription. The transcription model in Section 4.3 is modified with an inhibitor activity as follows.

Step1: Create an entity and set its name, e.g. doxorubicine.

Step2: Create a process and connect it to the doxorubicine entity with the process connector.

Step3: Connect the doxorubicine entity to the transcription process with the inhibitory connector.

Step4: Do not change the threshold of the inhibitory connector (the default value is 0).

The type of the doxorubicine entity can be either discrete or continuous. With the model in Figure 42, one can simulate the situation where the concentration of doxorubicine is growing. If the inhibition connector threshold is set to 0 for continuous processes the translation will be stopped immediately after the first

Sampling Interval. For a discrete process Translation will be stopped after the first step, as during the first step process (p1) is enabled.

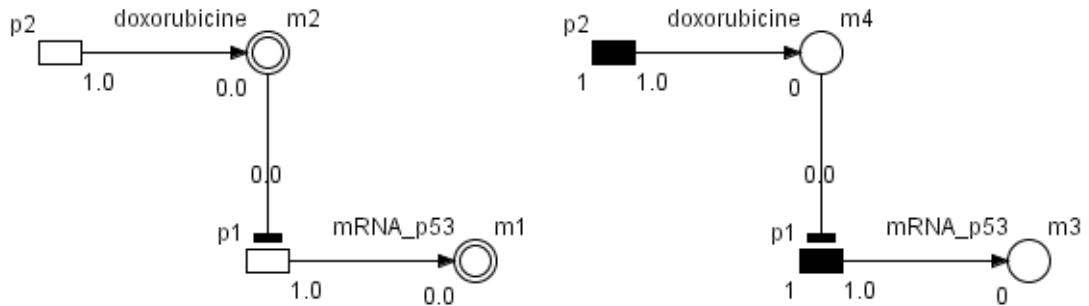

Figure 42

The results of the simulation are presented below (Figure 43)

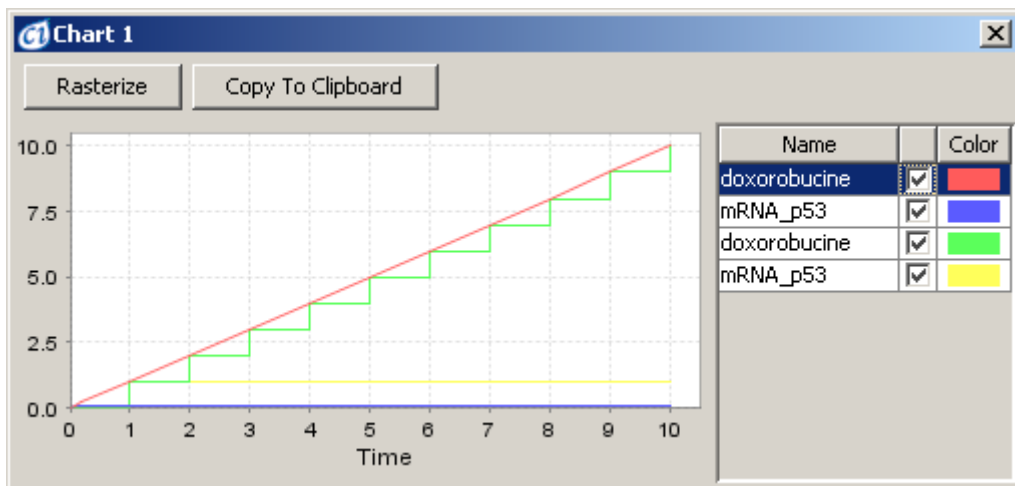

Figure 43

If the threshold of the inhibitory connector is modified to 5 (Figure 44) the results will be different. The results of the simulation are presented below (Figure 45)

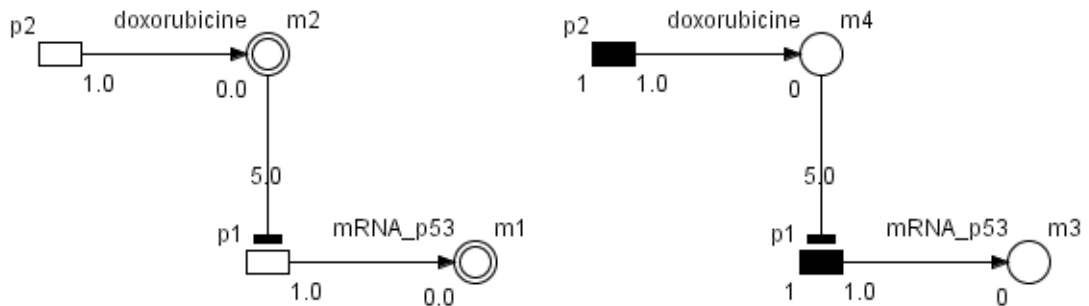

Figure 44

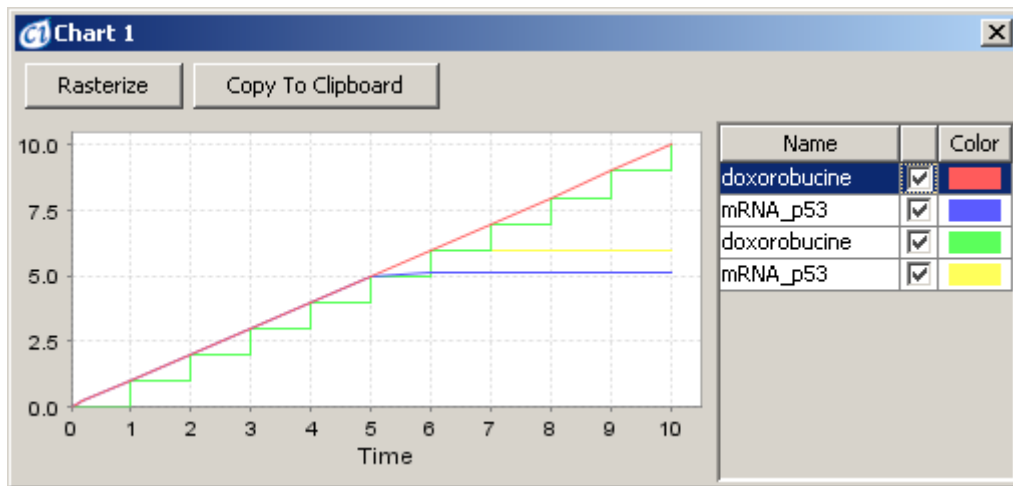

Figure 45

As in Figure 43 and Figure 45, if doxorubicine is treated the transcription of p53 is inhibited. The inhibitory activity will be adjusted with the threshold of the inhibitory connector.

4.10 Catalysis

Enzymes catalyze a variety of chemical reactions. The model of an enzymatic reaction can be created with the following steps. The first three steps are similar to the translocation process in Section 4.2.

- Step1: Create two entities and change their names, e.g. p53 and p53-P and set their values, e.g. 100 and 0.
- Step2: Create a process and set its name, e.g. catalysis. Connect p53 to the process and connect the process to p53-P.
- Step3: Set the catalysis speed by editing the speed option of the catalysis process (the default speed is 1.0).
- Step4: Create one entity and change its name, e.g. CAK.
- Step5: Create a process and connect it to the CAK entity with the process connector.
- Step6: Connect the CAK entity to the catalysis process with the association connector.
- Step7: Change the threshold of the association connector to 1(the default value is 0).

The type of CAK entity is continuous. With the model in Figure 46, one can simulate the situation where CAK (enzyme) concentration is growing. If the association connector threshold is set to 1 the catalysis process will be enabled when the CAK entity value reaches 1 level.

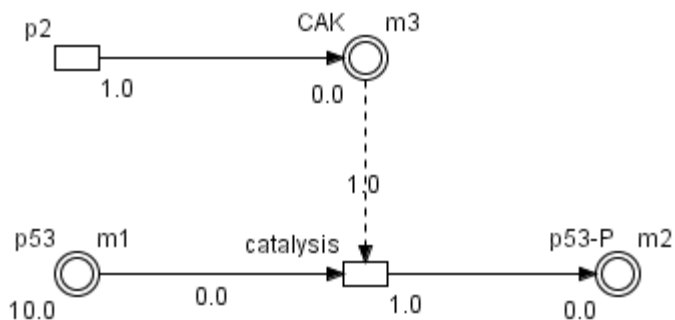

Figure 46

The results of the simulation are presented below (Figure 47)

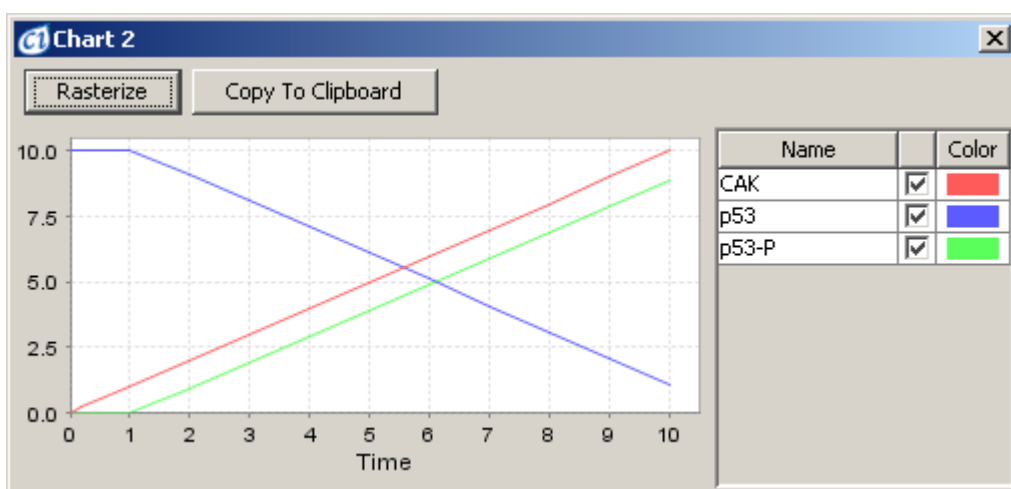

Figure 47

If the threshold of the association connector is modified to 5 (Figure 48) the results will be different. The results of the simulation are presented below (Figure 49)

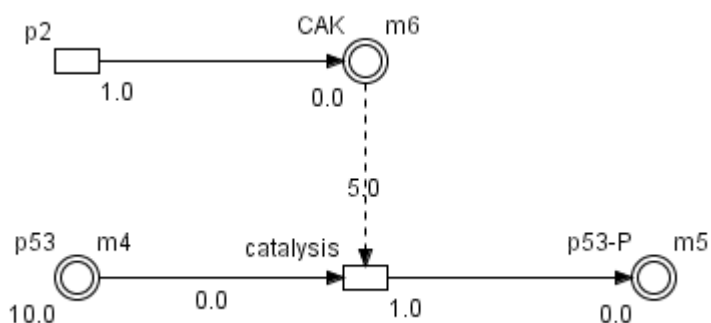

Figure 48

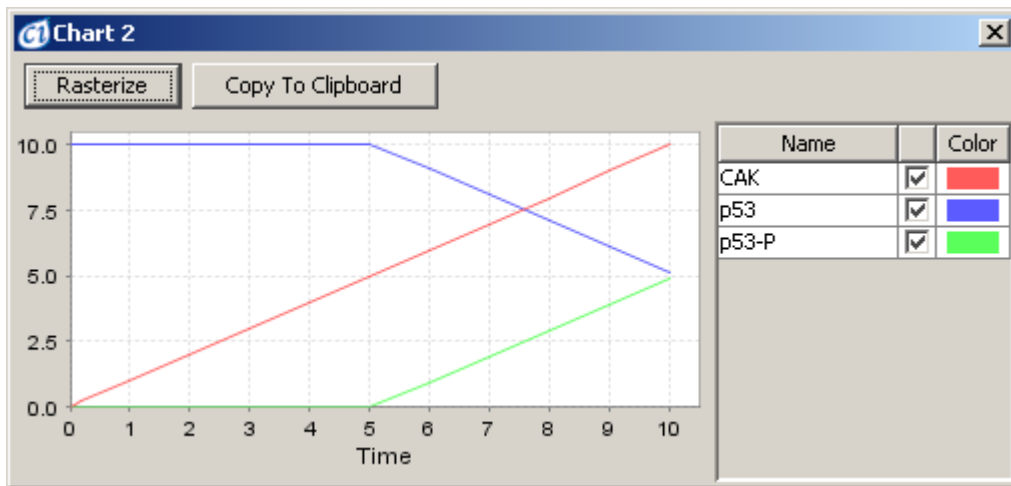

Figure 49

In the presented reaction, CAK influence on the model is enabling/disabling the reaction. The CAK activity will be adjusted with the threshold of the association connector.

However, in most of the systems, the reaction rate depends on enzyme concentration and substrate concentration. In the example in Figure 50, the speed of the catalysis process is defined with the equation $(m1*m2)/10$. The model is made of continuous type elements.

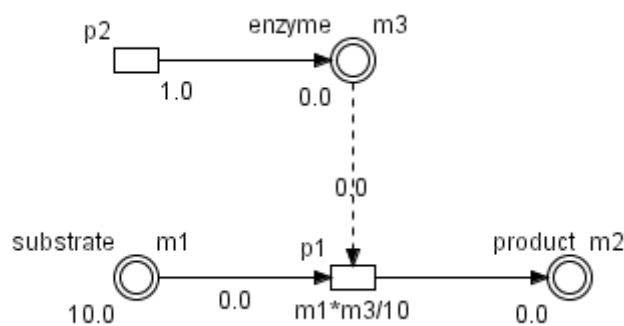

Figure 50

The results of the simulation are presented below (Figure 51).

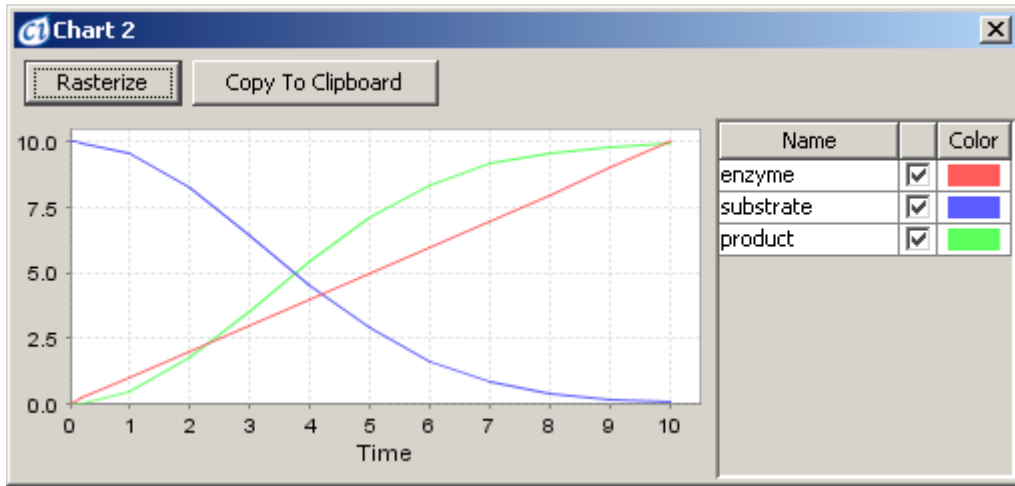

Figure 51

5 Cell Illustrator User Interface and Model Creation

At Cell Illustrator startup, a single main window pops up. You can create, open, save and print a biological pathway model file using options in the File menu (Figure 52).

This window has the Menu Bar at the top that allows you to manipulate the model diagram.

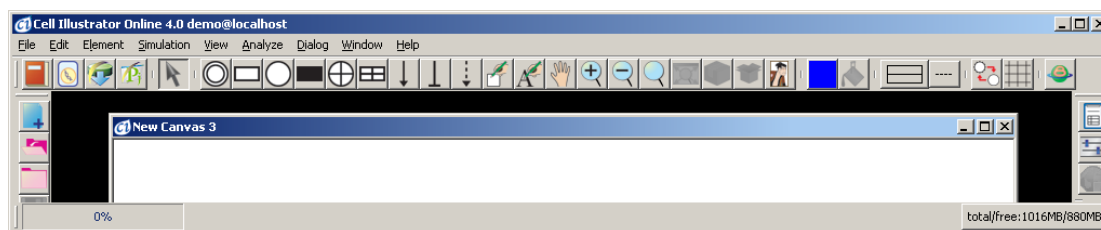







Figure 52

To create a new model, the first step is to open an empty canvas window for the model, which can be accomplished by either:

1. clicking on the top icon in the left toolbar (“Create New Canvas Window”)
2. clicking on the File in the Menu Bar and selecting the “New” option

5.1 Add Elements



To add a new element—an entity or a process, select one of , , , ,  and  icons from the top toolbar, and then click on the canvas workspace where you want to place it. You may continue and place more components of the selected type on the canvas.

Alternatively, you can press the right mouse button anywhere on the canvas and choose the desired element from the popup menu using Insert Entity/Insert Process function. The new element will be placed at the center of the active canvas.

Lastly, you can select a predefined element in the Biological Elements dialog (see Section 5.4.4)

Each entity has three labels associated with it for you to edit by double clicking (see Figure 1). On the upper left is the Name of the entity for associating biological concepts with the entity. The upper right label is the Variable representing this entity. It is used in mathematical equations to define the rate of reaction in the model. The lower left label represents the current value of the entity. You can edit it to enter the initial value for the selected entity. Note that for discrete entities, this value must be an integer.







A process can have up to four associated labels (see Figure 3). At the upper left is the Name of the process. The lower right label is the Kinetic Script of the process. The upper right label is the Firing Style of the process and the lower left label is the Delay of the process.













To add a connector to link two elements, select a connector type from ,  and  icons in the Edit toolbar above the canvas pane and then click on the element where the connection originates. Next, click on the element you want to connect to. The connector will be automatically drawn to connect the two elements. Note that a connector links entities to processes, not entities to entities or processes to processes. If you draw a connector between two entities, a process with default parameters is inserted between them. Also, discrete entities can not connect to continuous processes (see Element Combinations in Section 3.5). Generic entities can only connect to generic processes. Each connector has up to three labels: above the connector is its name, below is its firing style, and below the connector is its threshold (if threshold firing style is enabled) or the rule (if rule firing style is enabled) (see Figure 2). The threshold is a minimum value for the activation of the connector (see Simulation Concept, Section 6.1).

5.2 Modify a Model

The user can move any element within the model (i.e., change its location). To carry out this task, click on the Selection Mode  button from the Edit toolbar. Then, click on the element in the canvas and drag it to move it. You can also drag the mouse to select multiple elements and then right click the mouse to bring up a popup menu which allows to you to arrange, copy, cut, duplicate or delete the selected elements. A mouse right click on a selected single element will bring up a customized popup menu with additional options to modify the element.

The Edit toolbar contains buttons for frequently performed editing operations. This includes:



-  “Edit Parts” — Organize and use a repository of reusable model parts (see Section 8.3).
-  “Create Frame”— Create a background frame.
-  “Create Note” — Annotate the model.
-  “Manual Move” — Move the canvas window around the model without using the Navigator dialog or the scroll bars.
-  “Zoom In” — Zoom in on the canvas.
-  “Zoom Out” — Zoom out from the canvas.
-  “Reset Zoom” — Restore the default models magnification.













-  “Fit In Canvas” — Restore the default models magnification.
-  “Group” — Group together chosen elements to treat them as one for editing .
-  “Ungroup” — Undo a group operation.
-  “Load Image” — Load an image and insert the image to the canvas.
- “Set Color”— Apply the selected color to selected elements in the canvas as specified in the “Select Color Scope”.
-  “Select Color Tool”— Select the scope of Set Color operation:  Fill Color,  Line Color or  Text Color.
-  “Set Stroke” — Change the stroke pattern of selected elements.
-  “Toggle Grid Visible Status” — Turn the background grid on or off
-  “Toggle Antialiasing Status” — Turn on or off antialiasing
-  “Go to BioPACS URL” —Import metabolic pathway from public KEGG database (see Section 8.4).

5.3 Change Element Properties



For additional editing of the properties of elements in the model, the Property Dialog toolbar at the far right of the window is provided. Note that the Dialog menu contains all options provided in this toolbar.

The actions for each button are as follows:

-  “Toggle Element Lists Visible Status” — open or close the Element Lists dialog (see Section 5.4).
-  “Toggle Element Settings Visible Status” — open or close the Element Settings dialog (see Section 5.4).
-  “Toggle External References Visible Status” — open or close the External References dialog (see Section 5.4).

-  “Toggle Navigator Visible Status” — open or close a small view of the entire model to navigate the model in the canvas window (see Section 7.1).
-  “Toggle Preferences Visible Status” — open or close the Preferences dialog to change the graphical display properties of the various elements and global settings in this application (see Section 5.7).
-  “Toggle View Settings Visible Status”— open or close the View Settings dialog. The dialog changes the view settings of the active canvas, e.g., shows and hides entity names.
-  “Toggle Chart Settings Visible Status” — open or close the Chart Settings dialog to create time series plots (see Section 6.2.2).
-  “Toggle Simulation Settings Visible Status”— open or close the Simulation Settings dialog to change simulation parameters (see Section 6.2).
-  “Toggle Simulation History Dialog on/off” – open or close the Simulation History dialog. The dialog contains the list of all simulation log files for the active model file (see Section 6.3.2)
-  “Toggle Edit Units Visible Status” – open or close Edit Units dialog. The dialog provides defining and changing units.
-  “Toggle Biological Elements Dialog on/off” — open or close the Biological Elements dialog. The dialog contains customized entities, processes and images for modeling biopathways (see Section 5.4.4).
-  “Toggle Graph Layout Visible Status” – open or close Graph Layout dialog to set elements on the canvas in the specified way.
-  “Toggle Finder Visible Status” — open or close the Finder dialog to search for elements in the active canvas (see Section 7.2).
-  “Toggle Pathway Search Visible Status” — open or close the Pathway Search to search for elements in the active canvas (see Section 7.2).
-  “Open Show All Dialogs”— open all dialogs.
-  “Close All Dialogs”— close all dialogs.

5.4 Element Settings Dialog and Element Lists Dialog

The dialogs that show the details about the variables and equations in the model are the Element Lists (see Figure 53, Figure 55, and Figure 57) and the Element Settings (see Figure 54, Figure 56 and Figure 58). They can be opened either by selecting the options; Element Settings and Element Lists respectively in Dialog menu or by clicking on the buttons  and  in the Property Dialog toolbar.

The Element Lists dialog consists of three sheets: the Entity Sheet, the Process Sheet and the Connector Sheet. Each sheet contains a table of; all of the entities, processes, and connectors respectively in the active canvas and their main properties. You can easily change a property of an element by double clicking on the corresponding cell in the table. Note that the columns which can be edited have a white background while the columns that cannot have a gray background. To change an element property displayed in a gray-out column, you need to select a corresponding element in the canvas and open the Element Settings dialog.

The Element Settings dialog displays all the properties of a single element selected in the canvas. The dialog may display, depending on the type of selected element, one or two tabs from the following set: Entity tab, Process tab, Connector tab, Figure tab, and Image tab. Any modifications made in the Element Settings will be immediately reflected in the Element Lists and the canvas, and vice versa.

5.4.1 Entities

For entities, several properties are available for editing in both dialogs (see Figure 53 and Figure 54). A default setting is automatically displayed if you have not entered any value. You can change the name of the entity to reflect its biological meaning, and you can also enter the initial value of the entity. The current value of the entity is displayed once simulation data is available. To include the simulation data for this entity in a simulation output file, check the Log box. To make an entity public for inclusion in higher level models (see Section 8.2), check the box in the Public column. You can also control if the entity should be visible or hidden in the canvas by setting its corresponding checkbox in the visible column.

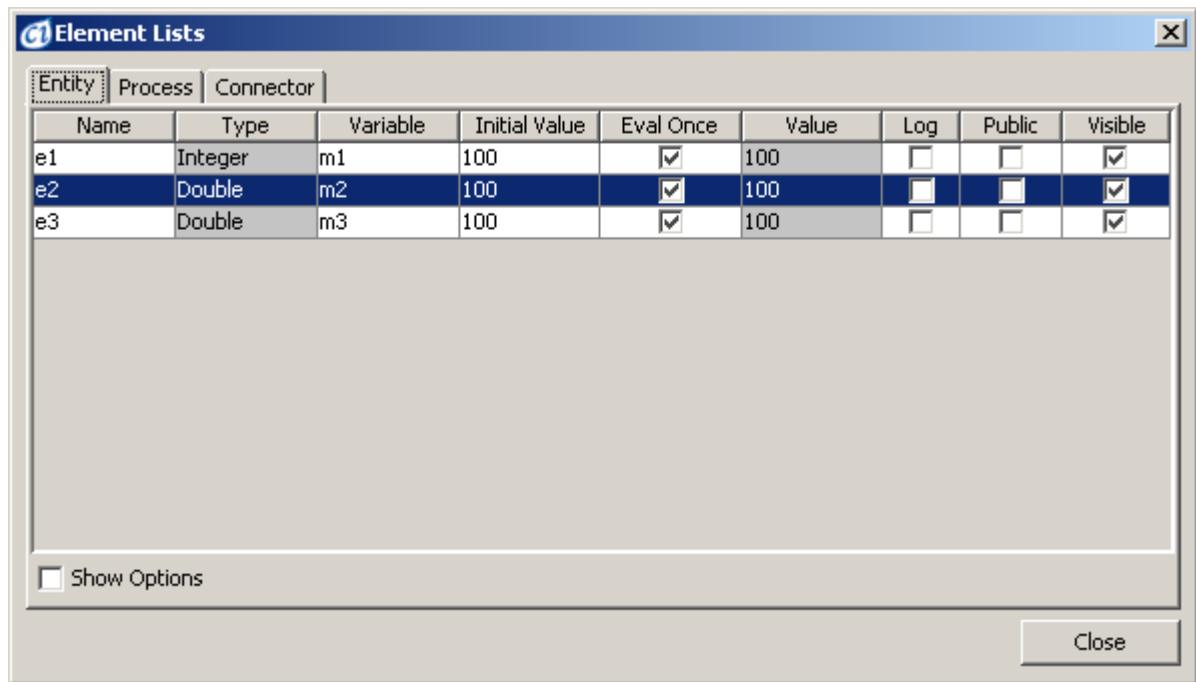

Figure 53

If an entity is selected in the canvas and the Element Settings dialog is activated, the properties of the selected entity are presented in the Entity Sheet and the Figure Sheet (Figure 54). The type of entity cannot be edited in Element Lists. However, it can be changed in the Element Settings dialog. A continuous entity can only have the Double value type, while a discrete entity be it Integer or Long or a generic entity can have the value type String or Boolean. The Maximum Value and Minimum Value fields define the allowable value range. The display properties associated with the selected entity can be modified in the Figure Sheet.

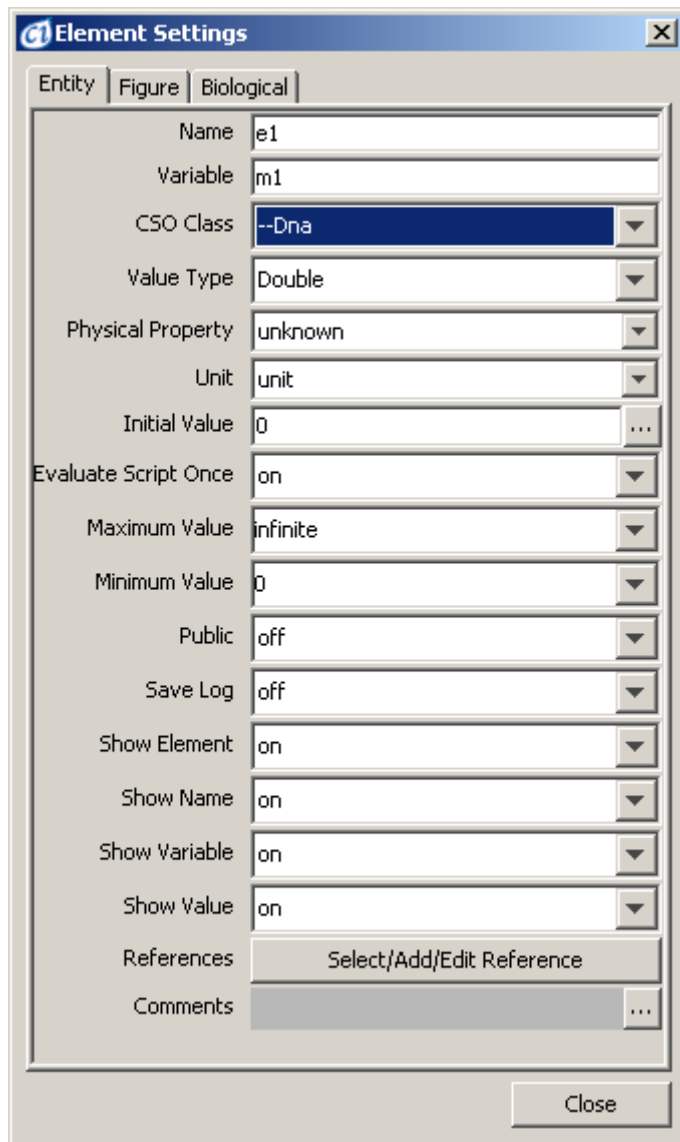

Figure 54

5.4.2 Processes

In the Process List in the Element Lists (Figure 55), you can change the name of the process to reflect its biological meaning. Also, you can set the Kinetic Script and Delay Script property. The Kinetic Script and Delay Script fields define, respectively, the speed / add / update function and delay parameter of the processes. The Kinetic Value and Delay Value columns display current simulation values.

Name	Type	Firing Style	Kinetic Script	Kinetic Value	Delay Script	Delay Value	Log	Visible
degradation	discrete	and	1	1.0	1	1	<input type="checkbox"/>	<input checked="" type="checkbox"/>
degradation	discrete	and	1	1.0	1	1	<input type="checkbox"/>	<input checked="" type="checkbox"/>
degradation	continuous	and					<input type="checkbox"/>	<input checked="" type="checkbox"/>

Figure 55

If a process is selected in a canvas, the Element Settings display the properties of the selected process on two sheets, the Process Sheet and the Figure Sheet (Figure 56).

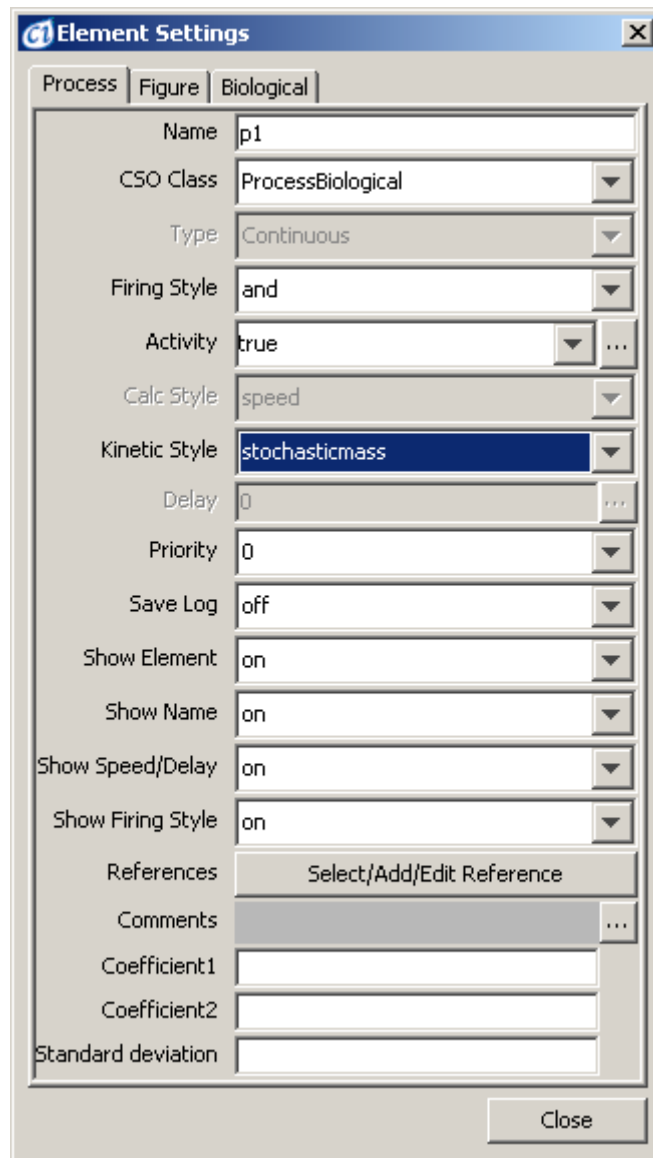

Figure 56

The major process parameters displayed in the Process Sheet are Type, Firing Style, Activity, and Kinetic Style. The Type property defines whether the process is discrete, continuous or generic and determines its calculation style (Calc Style field)

One can choose between two Firing Style settings – “and” and “or”. For a process with the default “and” firing style, if all input process connectors and association connectors of the process are activated and no input inhibitory connector of the process is activated, the process is *enabled*. For a process with the “or” firing style, the process is enabled if at least one of Association or Inhibitory input connector fulfills its condition and all input process connectors fulfill their respective conditions.

The Kinetic Style defines the method for calculating the values of connected entities. The property can have the following options: custom, connector custom, mass, stochastic mass or connector rate. Each style requires a specific set of parameters that you need to enter at the bottom part of the Element settings dialog. For example, you must specify the Coefficient1, Coefficient2, Standard Deviation and

Connector Stoichiometry for the Stochastic Mass style. The most general style is Custom. If a process has the Custom kinetic style, you need to specify directly its *kinetic script*, i.e., the formula that governs the value change. For other kinetic styles, the kinetic script is predefined and you can only set the values of parameters in the equation.

The Delay option is enabled only for a discrete process (see Section 3.4) and it takes a positive real value or zero (for continuous processes the delay is always set to 0). A discrete process will fire just after its delay time if the process is still active. Otherwise, it can lose its chance to fire. The delay is specified in Petri net time [pt].

By default, the Activity property of a process is set to *true*. However, you can write a script in the Activity field to turn the process *on* and *off* in the course of a simulation. For an example on how to write a script, see Section 5.4.4.

In the Figure Sheet, you can modify the display properties associated with the process.

5.4.3 Connectors

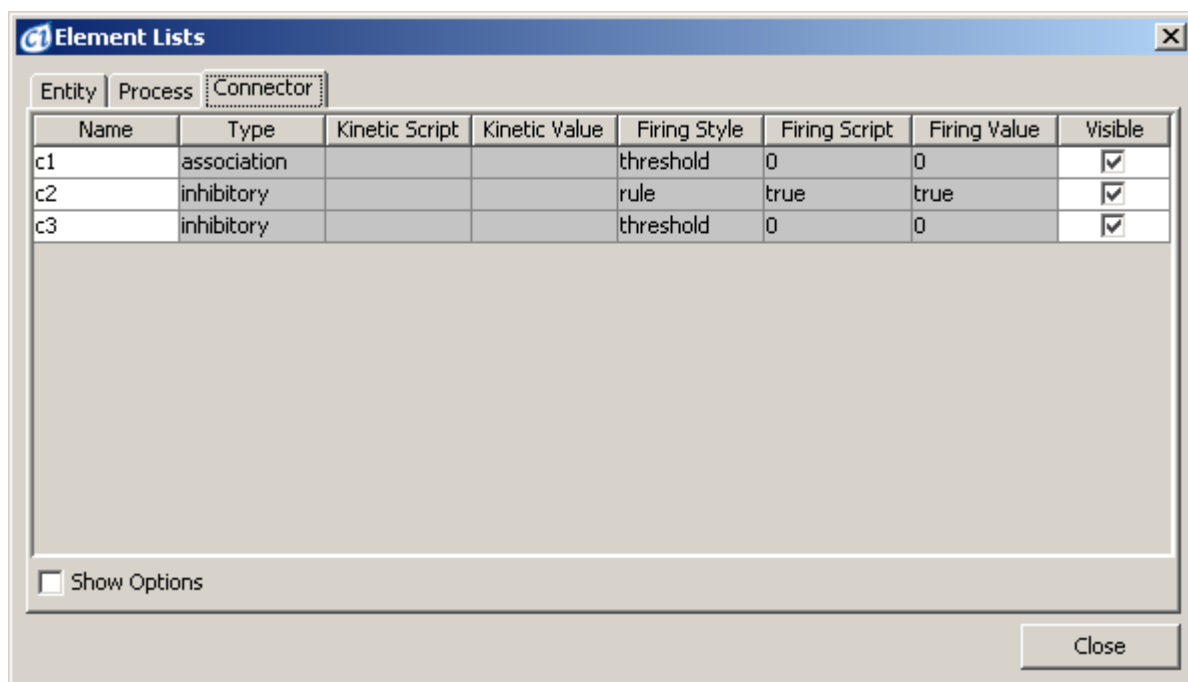

Figure 57

In the Connector List of the Element Lists dialog, the Name, Type, Kinetic Script, Kinetic Value, Firing Style, Firing Script and Visible properties are displayed (Figure 57).

When a single connector is selected in a canvas, the Element Settings dialog displays its properties on two sheets, the Connector sheet and the Figure Sheet (Figure 58).

The major properties that you can edit in the Connector Sheet are Type, Connector Firing Style, Firing Threshold and Firing Rule. A connector can be of the

process, inhibitory or *association* type. The Connector Firing Style option defines how the condition for activating the connector is calculated. (It should not be mistaken with the process Firing Style parameter.) The Connector Firing Style can take the Threshold, Rule or No Check value. In the Threshold style, the value of the Firing Threshold determines if the connector is enabled; if the current value of the source entity is larger than the threshold then the connector is enabled. In case the Connector Firing Style is set to Rule, the behavior of the connector is defined by a boolean expression (script) in the Firing Rule field. No Check option always enables the connector.

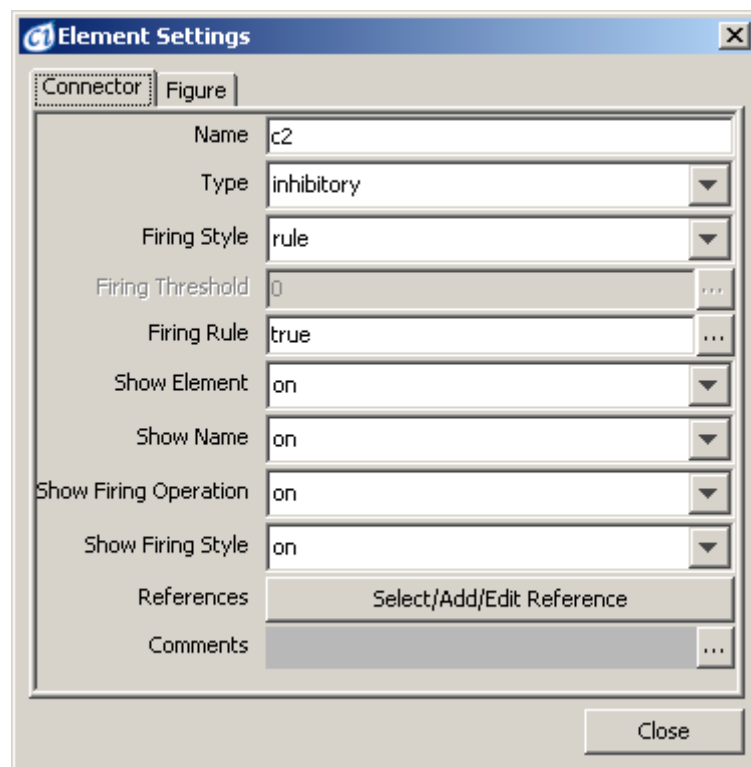

Figure 58

5.4.4 Biological Properties Tab

The *Biological Properties tab* available in the Entity/Process Settings dialog box enables you to set additional biological information for the selected entity or process, such as location, GO ID, list of Pubmed ID's. For a process you may select the Process type from a list of predefined choices. Please note that changing the process type will assign the graphical symbol (image) of this process to the figure on the canvas. For an entity a list of references to external databases can be defined, e.g. UniProtID, EntrezGeneID, MIMID, etc.

5.4.5 External References Dialog Box

Using this dialog box, you may define for each model element a list of references to external databases or vocabularies. The defined links can then be opened and viewed in a web browser.

5.5 Biological Elements and Pathway Fragments

While you can use the menu options and toolbar buttons described in Section 5.1 to add elements, biological pathways can be created faster and more intuitively by dragging and dropping appropriate elements from the dialog boxes that support building of pathways. These dialog boxes give the user the access to many predefined elements or pathway fragments and the ability to insert these fragments to the active canvas.

5.5.1 Biological Elements Dialog

The Biological Elements dialog contains the Entity Sheet, the Process Sheet and the Others Sheet.

The Entity Sheet contains biological elements that will contain a certain quantity, e.g. mRNA and protein (Figure 59).

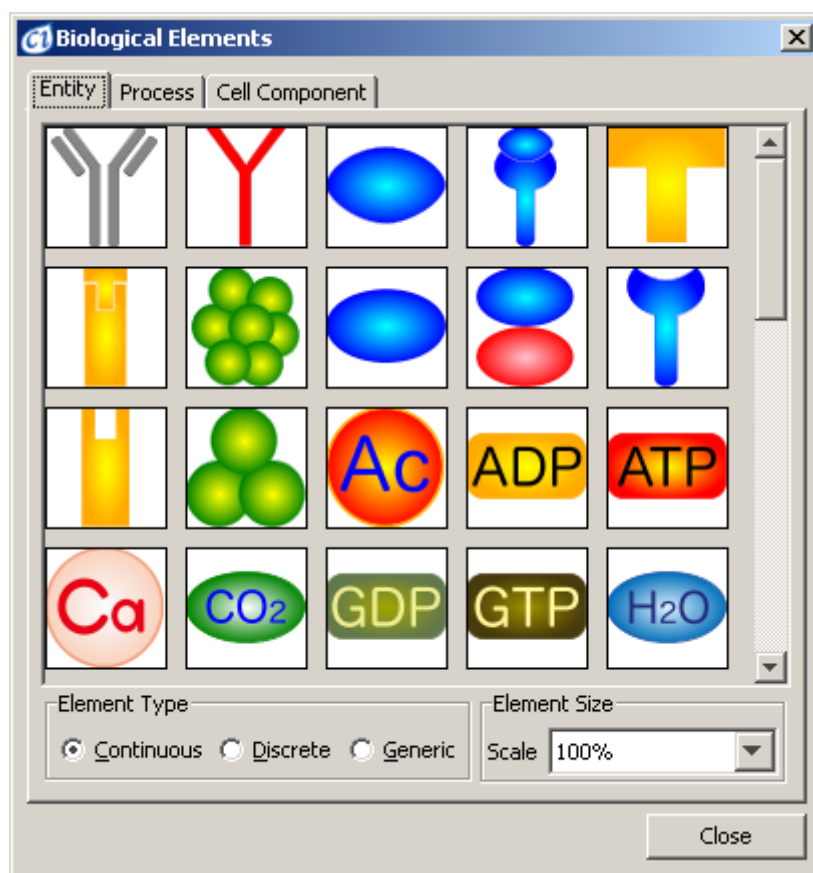

Figure 59

The Process Sheet contains biological elements that denote biological processes, e.g. phosphorylation and translocation (see Figure 60).

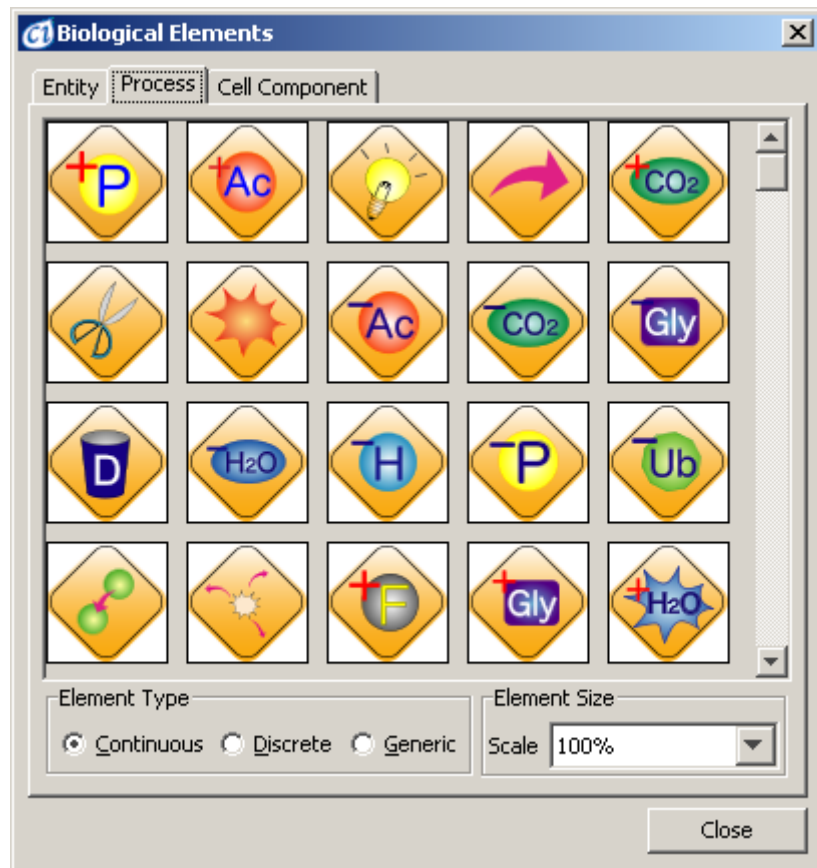

Figure 60

The others sheet contains useful pictures of cellular components, e.g. cell and mitochondrion (Figure 61).

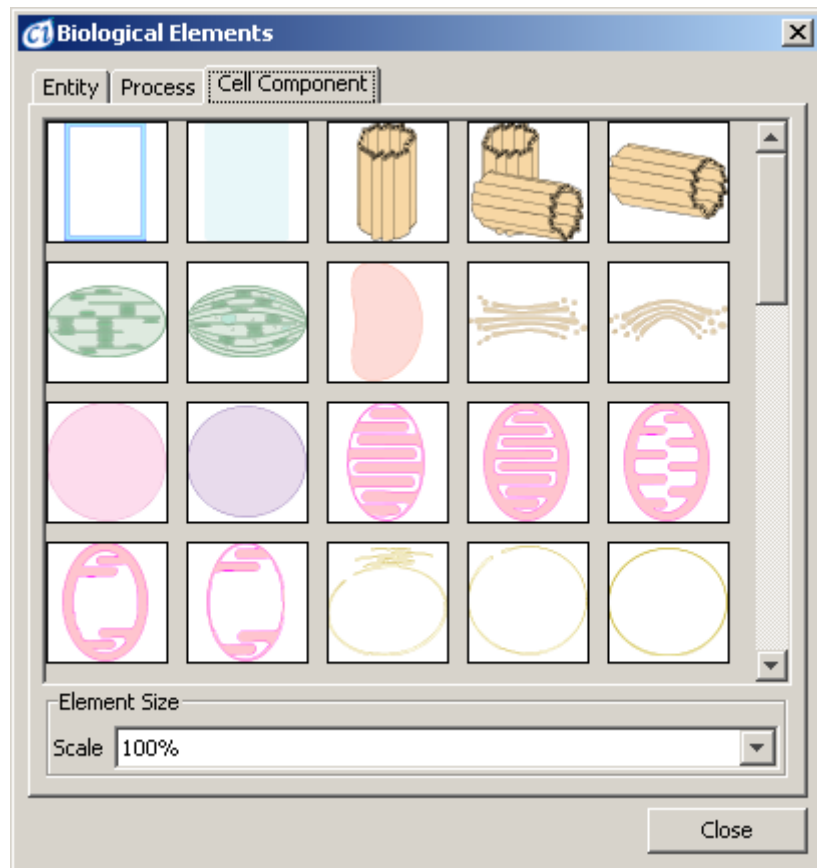

Figure 61

5.5.2 Project Manager Dialog

CI Project Manager is a user interface to pathway models stored on *CI Online Server*. To access the remote *CI Online Server*, the user must be logged in.

In this dialog box, you can:

- Organize your models and projects stored on Cell Illustrator Online Server.
- Share your projects with other users, and use projects shared by others. See the CI Reference Manual for details.
- Browse and search through pathway libraries defined on the *CI Online Server* and open selected models in CI workspace.

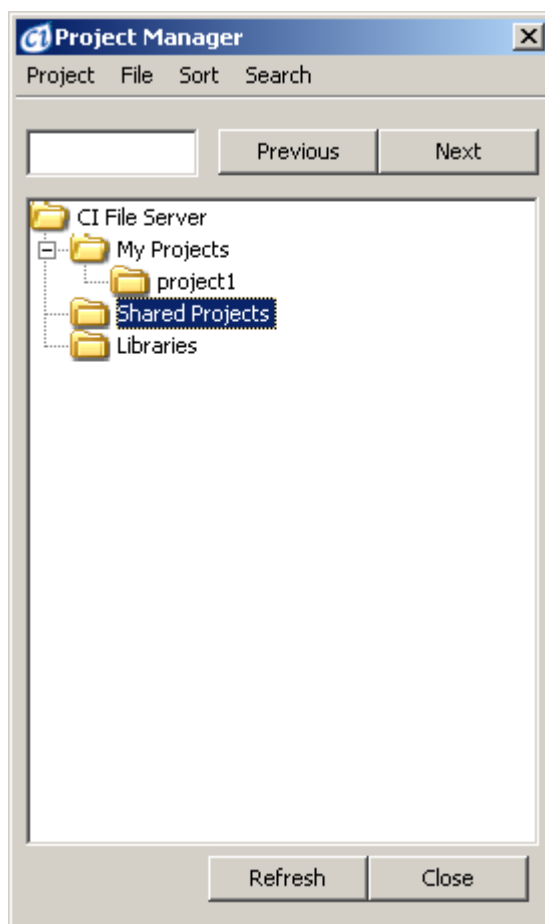



Figure 62

To open Project Manager Dialog, choose  icon from the top toolbar.

5.5.3 CSMLDB Search Dialog

The *CSMLDB Search Dialog Box* is an interface that allows for submitting queries to the remote CSMLDB database. To access the CSMLDB database, the user must be logged in to the *CI Online* server.

Using this dialog you can search in the CSMLDB database for molecules (entities) and/or reactions (processes) and import them into active canvas.

To open CSMLDB Search Dialog, select  icon from the top toolbar.

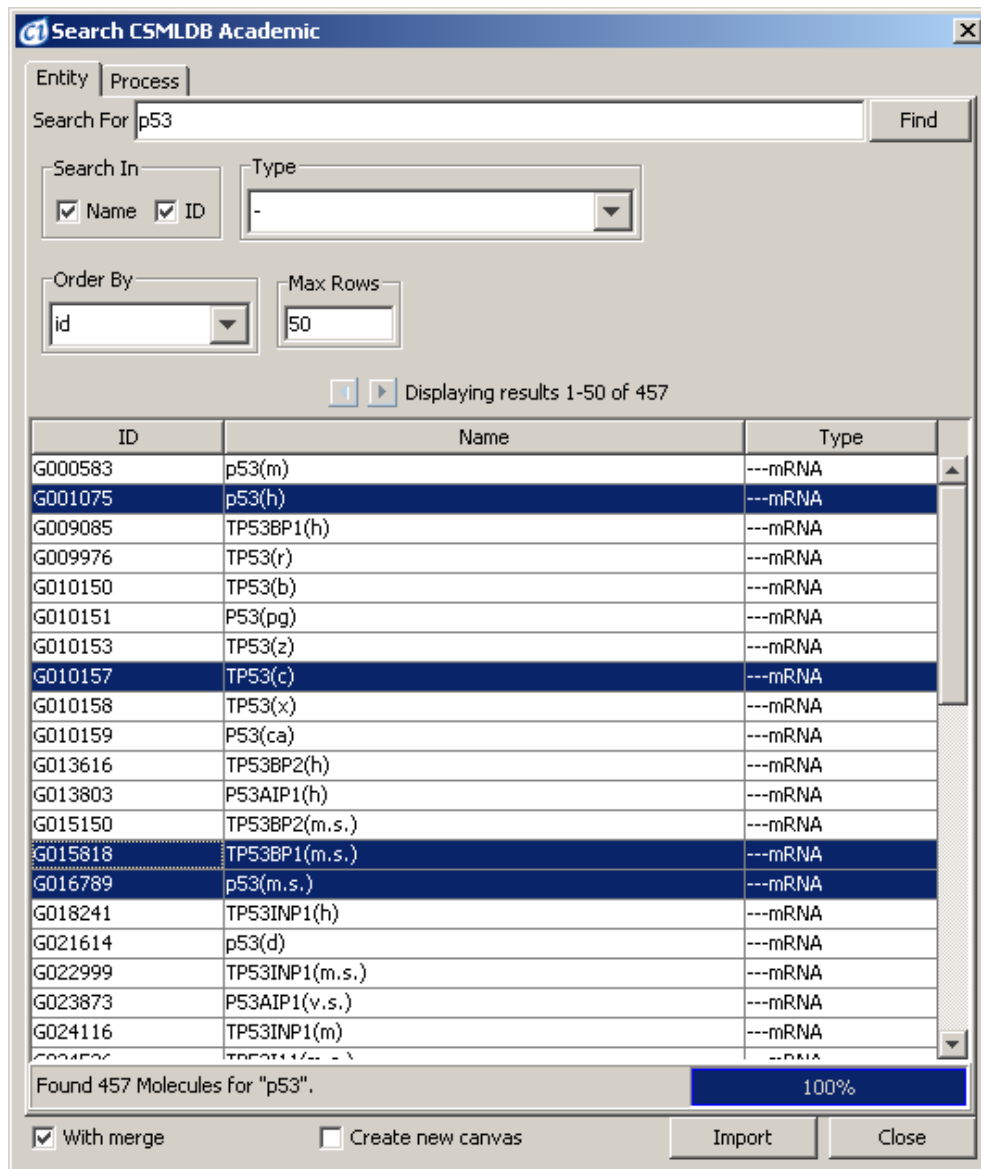

Figure 63

5.6 Script Editor and Pnuts Scripts

An advanced user of Cell Illustrator may need to write a custom function to specify changes of a property value. With the Script Editor, you can write a Pnuts script to define

- Initial Value property of an entity,
- Activity, Speed / Add / Update and Delay of a process,
- Threshold, Updater and Firing Rule of a connector.

Pnuts is a script language for Java environment. The Pnuts Language Reference can be downloaded from the project website at <https://pnuts.dev.java.net/> .

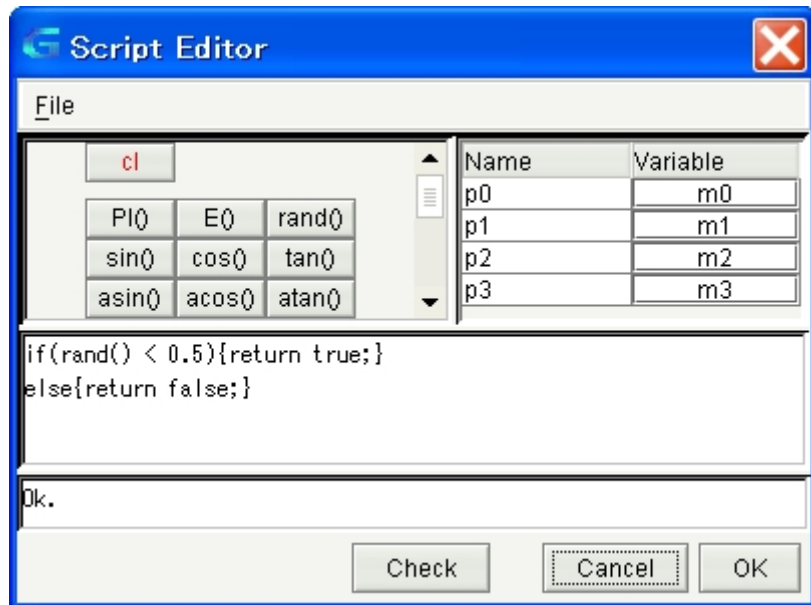

Figure 64

Figure 64 shows the Script Editor. At the top left in the dialog is a set of function buttons. At the top right is a table containing all entities in the model. In the middle, a script pad is placed where you can edit a script either by clicking on the function buttons and selecting entities from the table, or by typing in text. Remember to press the Return key at the end of the script. You can check whether the syntax of your script is correct by pressing the Check button. Error messages will appear in the bottom panel.

5.6.1 Pnuts Script Examples

5.6.1.1 Example 1: Stochastic Behavior of Translocation Process

Many processes in a cell show stochastic behavior. In order to model a stochastic translocation process, the model in Section 4.2 was modified by applying a script in Figure 64 to the *Activity* option of process p1. The results of the simulation of the discrete model with the sampling interval equal to 1 are presented in Figure 65. The figures compares 2 discrete processes, one randomly activated and the second always active process. Note that the value changes of the p53_nuclei (random) entity are not steady.

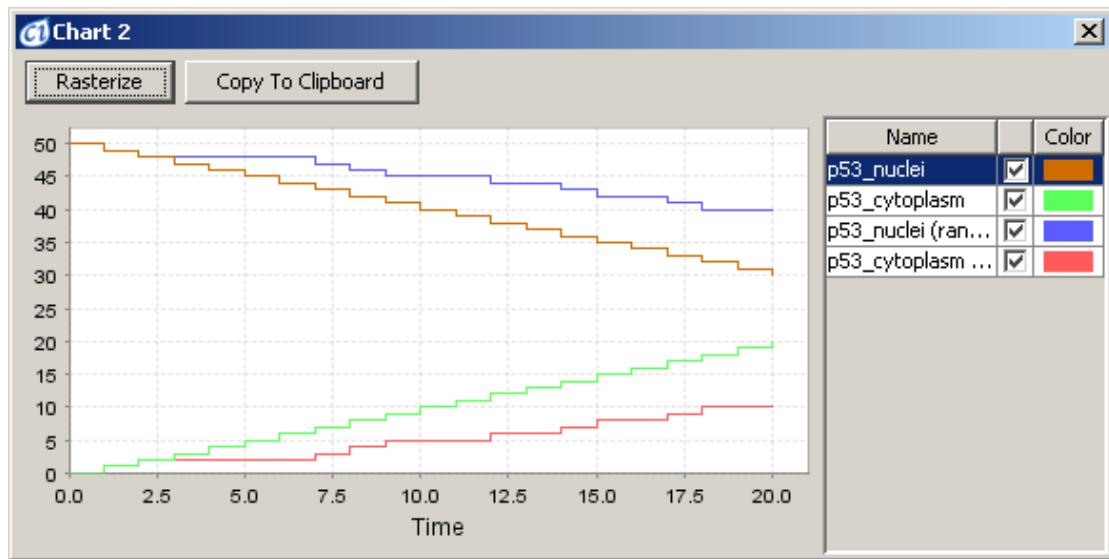

Figure 65

5.6.1.2 Example 2: Transcription Process with Generic Entities and Processes

Generic entities are of two value types. For example, you can use an entity that holds a String variable to describe a translation/transcription process with a generic process.

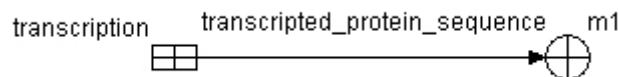

Figure 66

In this example, a script shown in Figure 67 is assigned to the Updater property of the connector.

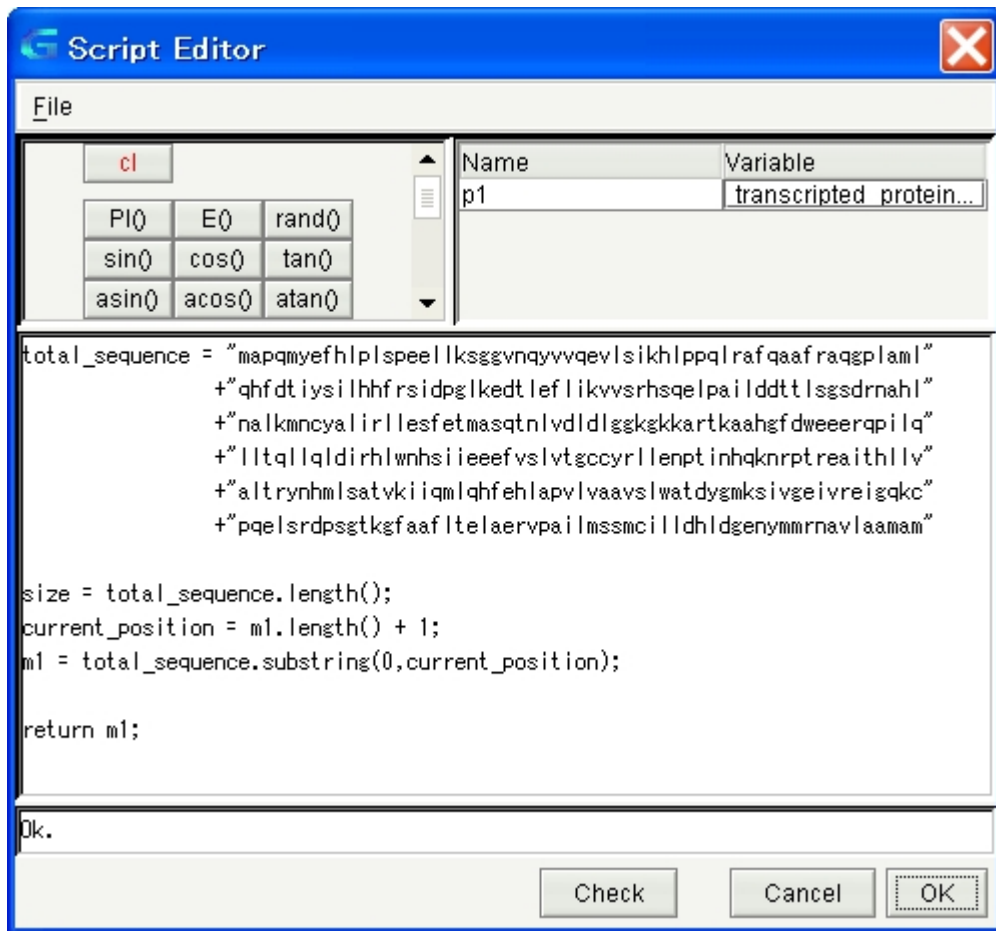

Figure 67

Selected succeeding states of the model in Figure 66 are presented in Figure 68.

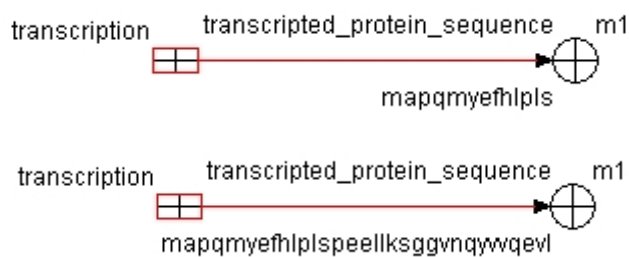

Figure 68

5.7 Preferences Dialog

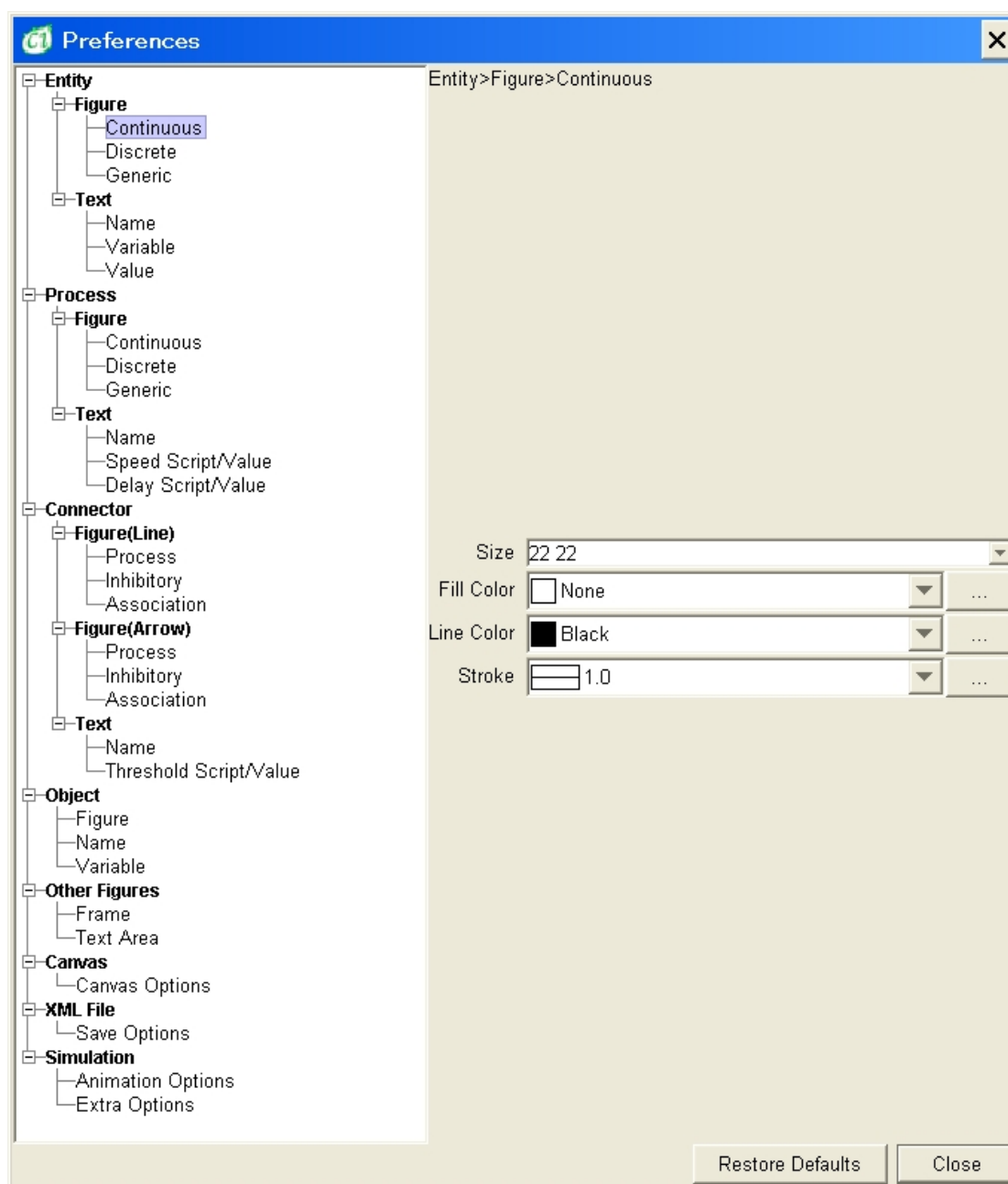

Figure 69

With the Preferences dialog, you can set the global properties of Cell Illustrator. This section briefly introduces the major options available in the dialog. The dialog displays a tree of option types and, for a selected part of the tree, the list of available options and their settings. For example, Figure 69 shows the global settings of the figure to be used for display of continuous connectors. One can define the size of the figure, its color and other parameters.

The Canvas options define the way the canvas looks. The background color and the grid size can be defined here. Alternatively, you can update major canvas options in the View Settings dialog.

The XML File | Save Options define properties of XML files that store Cell Illustrator models such as the encoding type of the XML format.

The Simulation | Animation Options define visualization parameters of simulation. On the other hand, the Simulation | Extra Options define the default parameters of a simulation process. The values of Sampling Interval, Plot Update Interval, Log Update Interval, Max Speed and Simulation Time displayed in the Preferences are used as the default parameters in the Simulation Settings dialog.

5.8 Graph Layout Dialog

In this dialog box, you can “beautify” the graph layout of the model. This function can be especially useful when importing models from the BioPACS database or converting models from other formats.

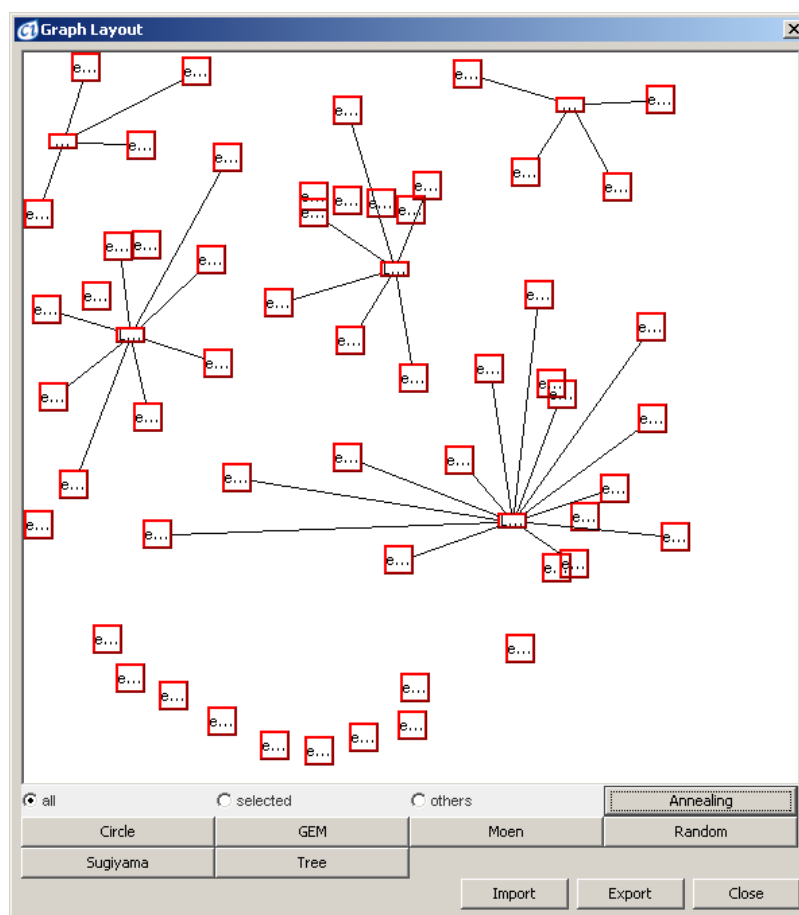

Figure 70

The Graph Layout dialog has several options for placing elements on the canvas such as Annealing Layout, Circle Layout, and others. See the CI Reference Manual for details.

6 Simulation

6.1 Simulation Concept

The simulation architecture of Cell Illustrator is based on the *Hybrid Petri-net with extensions* (HFPNe) theory [10] and uses the concepts of entities, connectors and processes. With discrete elements, you can execute basic logic-based simulations. You can also execute differential equation based simulations with continuous elements, and combine discrete and continuous elements in more complex models. The most advanced simulations would employ generic elements and scripting. For a short introduction to the HFPNe theory, see Section 3.

It is easy to prepare a basic simulation just by drawing biological pathways on the canvas. A simple model can be then turned gradually into a more advanced one by adding detailed information to HFPNe elements in the biological pathways, e.g. kinetics data and detailed regulation rules. To build a model quickly, drag and drop biological elements from the Biological Elements dialog (Section 5.4.4) and link them with connectors observing the connection rules listed in Section 3.5. All element parameters are initialized with default values; the initial value of an entity is 0, the threshold parameter of an input connector is 0, and the speed parameter of a process is 1 by default.

For any biological process to take place during simulation, the process representing it needs to be enabled. A process is enabled when all the following three conditions are satisfied; (i) all of its incoming process and association connectors are activated, (ii) no input inhibitory connector is activated, (iii) the *activity* parameter of the process is *true*. (The default value of the activity parameter is *true* but one can write a script that modifies this parameter.) Once a process is enabled, the biological process can occur. Let us take a look at the simulation of a simple case: A protein precursor is phosphorylated to be an active protein.

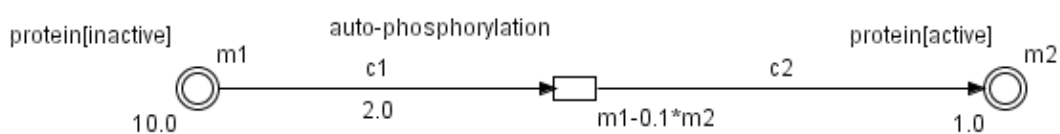

Figure 71

The initial value of the protein [inactive] is 10. While the concentration of protein [inactive] is greater than the threshold of its outgoing connector c1 which is 2.0, the connector is in the enabled state. An enabled connector in this case executes the activation of the Phosphorylation. The protein [inactive] will be converted to the active protein, protein [active] at the speed of phosphorylation which is $V(t) = dm_0/dt$. In another words, the concentration of protein [inactive] will decrease by the amount $(m_0 - 0.1 * m_1) * \text{time}$, and the concentration of protein [active] will increase by the same amount. Once the concentration of protein [inactive] reaches the threshold value 2, the connector will be deactivated. Consequently, the process of phosphorylation is terminated. The end simulation state is displayed in Figure 72.

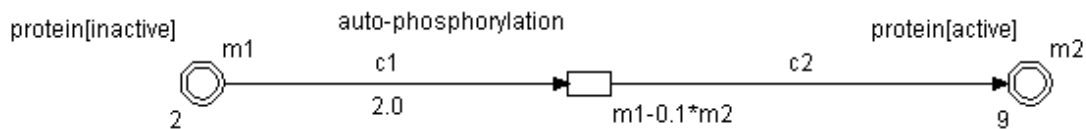

Figure 72

Figure 73 presents a simulation chart for this model.

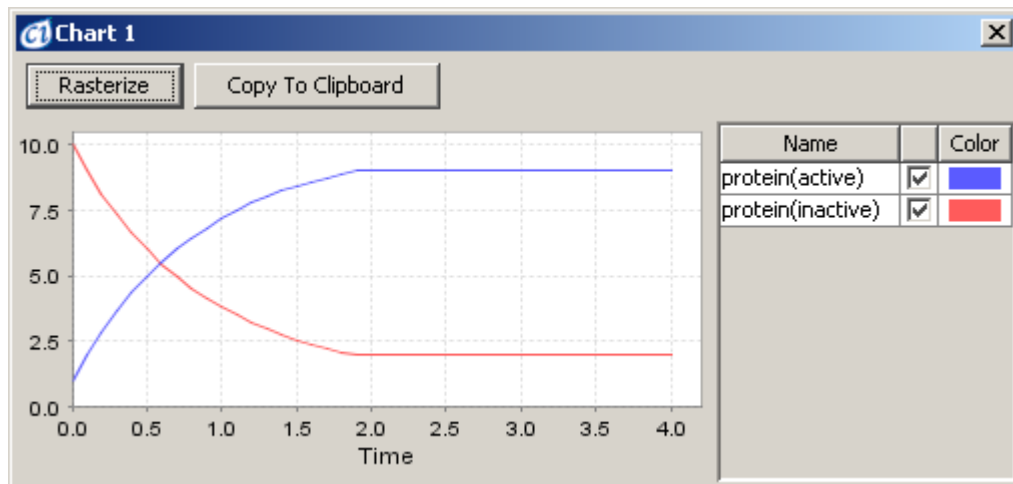

Figure 73

When simulating a complex pathway, you will often need to construct multiple entities with multiple connectors leading to one or more processes. In these cases, only when all process and associate input connectors are activated and all inhibitory input connectors are not activated, the process is enabled. For each simulation step, all the activation conditions for all processes are checked and all activated processes are executed in a random order.

The simulation run can be logged and saved into CI log files (CILs) – refer to [Simulation Log](#). Saving log files gives you the following possibilities:

- View and replay a simulation step by step in CI Player application – refer to [Simulation Replay](#)
- Order and systematically analyze the results for a set of similar simulations – refer to [Simulation History](#)

Creating a log file and replaying it in CI Player is recommended in the following cases:

- When the simulation may take a large amount of time, e.g., for a complex model and accurate simulations.
- When you run a set of simulations for the same model and the simulation results may differ from one simulation run to another, for example. For a model with random factors, or for a model with changed parameters.

6.2 How to Set Up and Run Simulation

6.2.1 Simulation Settings

The next step after creating a model is to set up simulation process parameters. The Simulation Settings dialog has the following options that control the simulation flow: Sampling Interval, Plot Update Interval, Log Update Interval, Simulation Time, Continuous and Discrete Weak Firing, Firing Accuracy and Simulation Speed (Figure 74).





During simulation, the model changes its state in a certain time sequence. In Cell Illustrator, simulation time is measured in virtual time units called Petri net time (pt). The Simulation Time option sets the duration of the simulation process in Petri net time. If the Simulation Time is set 2000 as in Figure 74, the simulation lasts from 0[pt] to 2000[pt]. Note that the value of the Simulation Time parameter does not necessarily correspond to the real time it takes to execute the simulation on your machine. The latter depends also on the complexity of the model, additional simulation parameters such as the Sampling Interval and the hardware on which the Cell Illustrator runs.

The Sampling Interval specifies the interval at which simulation steps are executed. Again, the Sampling Interval is defined in Petri net time units. At each step, model state changes are computed. If the interval is 0.1pt as in Figure 74, the model changes its state at 0.1[pt], 0.2[pt], 0.3[pt]... 2000[pt]. If the Sampling Interval becomes smaller, the simulation becomes more accurate but calculation performance decreases. For example, for 1[pt] simulation, Cell Illustrator needs to perform 100000 simulation steps if the interval is 0.00001[pt] and only 10 steps if the interval is 0.1[pt]. The minimum sampling interval allowable in Cell Illustrator is 0.000001 pt. You should be aware; however, that simulation with the minimum sampling interval may take a very long time.

If the sampling interval becomes very small, the simulation result will be similar to a differential equation model (see Appendix B).

The Weak Firing option solves a problem of non-firing processes. This may happen when the value associated with an entity is smaller than the calculated change of this value (Δ) within a given sampling interval. If this happens, the process does not fire at all. This behavior is an inherent consequence of the classical Petri net formalism. However, it may lead to an unexpected, unrealistic simulation behavior, e.g. when the kinetics of catalyzed reactions in biological systems are modeled – a catalyzed reaction may not “occur” at all, even if a substrate and a catalyst are present!

The Weak Firing can be enabled/disabled for continuous or discrete processes. By default this option is off which is in agreement with the Petri Net model, but is sometimes difficult to understand for normal biological reactions.

Cell Illustrator has several commands to run a simulation. If the Play , Play with Animation , Fast Play  and Max Speed Play  buttons in the Simulation

toolbar are clicked, the simulation will run until the end. Clicking on Step Play ▶ and Step Play with Animation ⚙ buttons executes a simulation step corresponding to one sampling interval.

If a simulation process is started with the Play or a Play with Animation button, the program attempts to execute the simulation at the speed 1 pt per 1 second regardless of the Simulation Speed option in the Simulation Settings dialog. On the other hand, for simulation started with Fast Play and Max Speed Play, Cell Illustrator attempts to execute simulation at the rate defined by the Simulation Speed. For example, if the Simulation Speed is set to 100, then the simulation will proceed at 100 Petri net time units per 1 second of real time provided that your hardware is sufficiently fast. You may need to increase the Sampling Interval at the cost of result accuracy if the simulation is too slow. The difference between Fast Play and Max Speed Play is that the canvas is not updated until the simulation end if the latter option is executed. Thus, you should use the Max Speed Play for time consuming models.

The Log Update Interval option defines how often entity values are saved in the simulation log. To track value changes for a specific entity, you need to set its Log option to the *on* value.

The Chart Update Interval defines how often simulation charts are updated. This option has no meaning for simulations started with the Max Speed Play command.

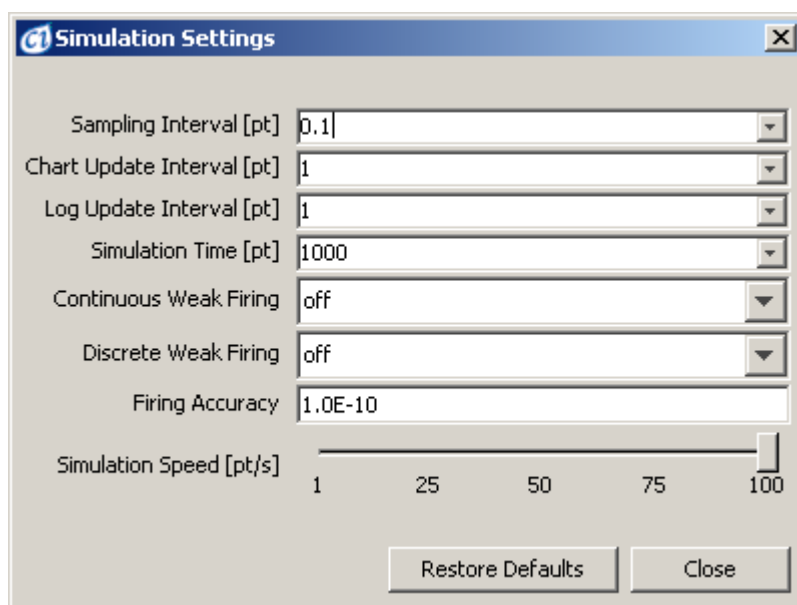

Figure 74

6.2.2 Simulation Log

The results of each simulation can be logged and saved into CI log files (CILs). The CIL files can be viewed and analyzed in the Cell Illustrator Player program. The simulation log can also be exported to a CSV file and then analyzed with an external spreadsheet application.

A CI log is an XML file that consists of two parts: the input model and a time series of values for the logged properties. The time series data may include:

- entity values and/or
- process state (firing, waiting to fire due to the delay property, not-firing)

You can define the entities and processes to be logged in the Element Lists dialog by selecting the Log option as it is illustrated below:

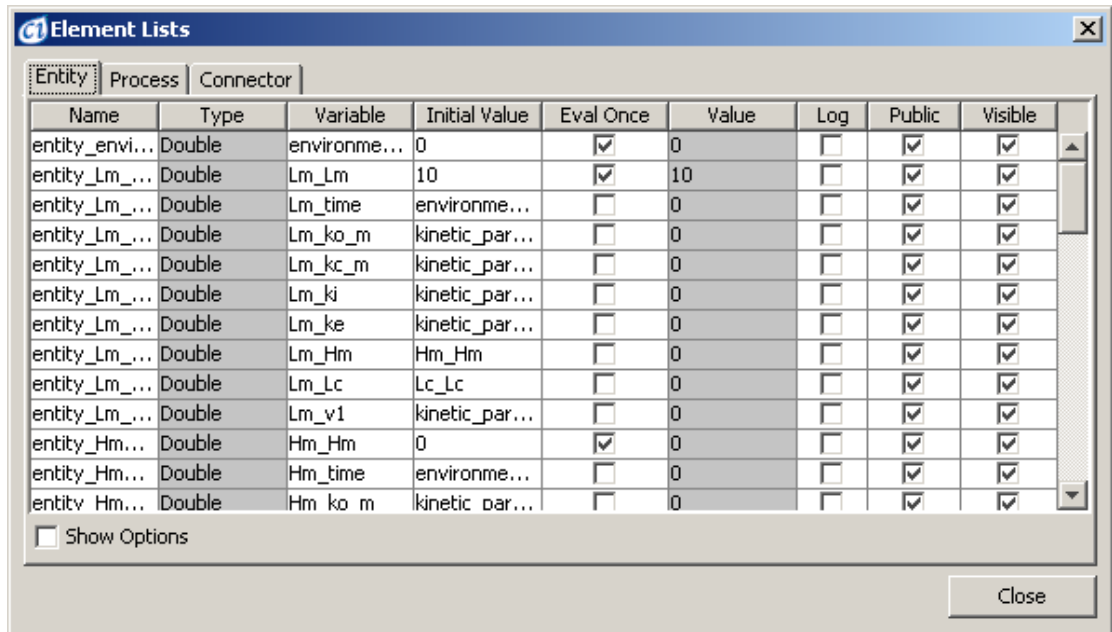

Figure 75.

By default, the Log option of all entities and processes is off. This means that nothing will be logged during simulation and a CIL file will not be created during the simulation. A CIL file is created if at least one entity or process is selected for logging. You can set the Log flag for all entities or processes at the same time by setting the *Column* selection box in the *Options* panel and clicking on the *Log* column. (The *Row* selection checkbox in the *Options* panel must be unchecked.)

At the simulation time, the data is logged time points defined by the *Log Update Interval* setting in the [Simulation Settings](#). The log interval value needs to be selected carefully so that an appropriate number of steps is logged during the simulation. In general the number of steps that will be logged is given by the following formula:

$$N_STEPS = \frac{SIMULATION_TIME}{LOG_INTERVAL}$$

It is recommended to select the log interval in such a way that the number of steps will be less than 100 000 steps. Logging hundreds of thousands of steps will cause the CIL file to be very large.

The formula for the number of steps (N_STEPS) is accurate if entities **only** are logged. In case processes are logged as well, each simulation step in which a process state changes is added to the log. This means that the log may include many additional time points besides the time points defined by the log interval. In such a case the number of logged steps can be greater than the value given by the formula.

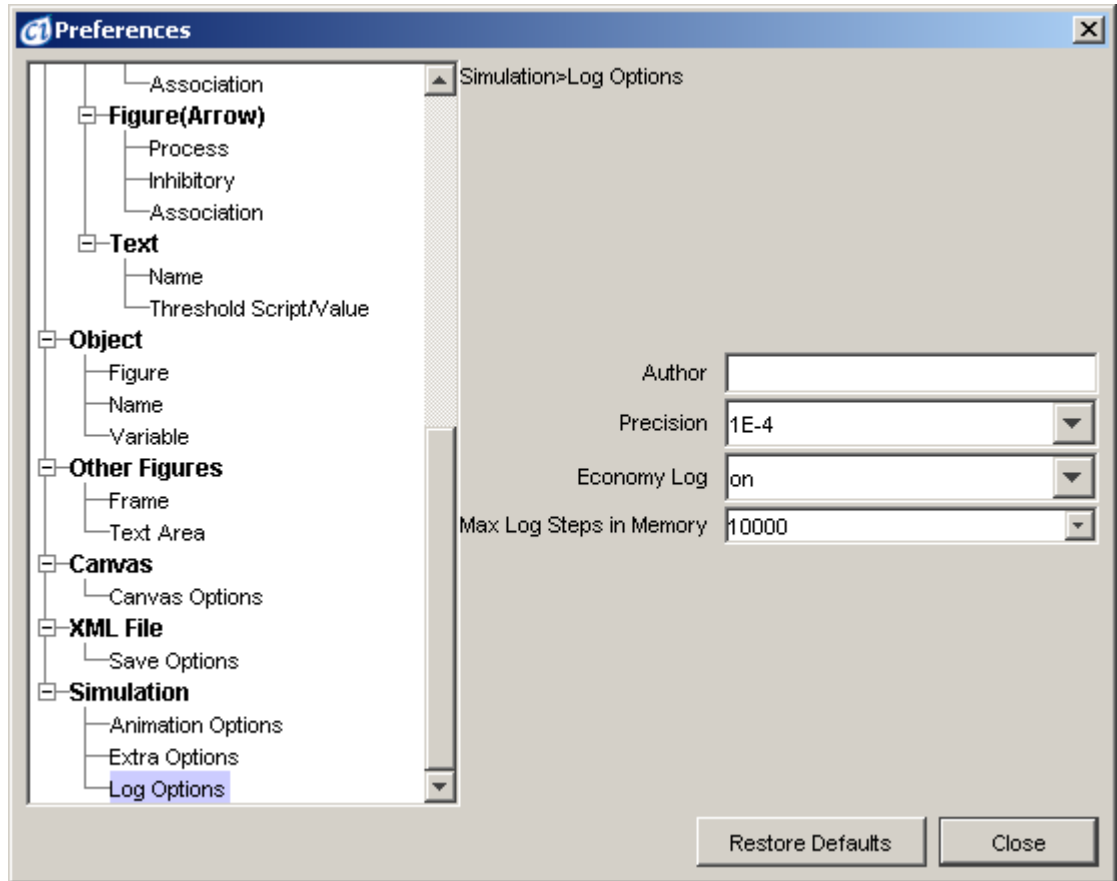

Figure 76

There are several log options that you can set in the Preferences dialog. In the Simulation | Log Options panel, you can specify the following parameters:

- Author - the name of the person who runs the simulation. This name appears in the Simulation History dialog.
- Economy Log – specifies whether to minimize the size of a CIL file by not writing identical values. The recommended state of this value is on. It can be turned off only in special cases.
- Precision – this value specifies how to round up floating point values. The Log Precision defines the minimal difference between two floating point values in the log.
- Max Log Steps in Memory – this value specifies the size of the log buffer in the RAM memory. If the number of steps in the log exceeds this value the buffer is emptied by writing the log to the

hard disk. The simulation is suspended during the write to disk operation and resumes when the operation completes.

Since CIL stores the model in the same format as in the original project file, you can open a log file with Cell Illustrator and edit the model. However, saving the edited model into the original log file will erase the time series and any other simulation history information. Therefore, you should use the Save As command of Cell Illustrator if you would like to recover the model from a log file for further editing.

6.2.3 Simulation Charts

You can visualize the simulation results with concentration or amount versus time graphs. Charts can be defined in the Chart Settings dialog (Figure 77). Click on the  button in the Property Dialog toolbar to bring up the Chart Settings. A table at the left side of the dialog displays all entities in the active canvas. The Chart Tree at the right side displays all defined charts for the model in the active canvas. Select an entity in the table and click on the Add Selected Entities button to create a chart that tracks the entity value over time. A newly created chart is added to the tree. To add an entity to an existing chart, highlight the chart name in the tree, select the entity in the table and press the Add Selected Entities button. The maximum number of entities in one plot is 8. You can also delete charts; Highlight names of charts to be deleted in the Chart Tree and press the Delete Selected Charts button.

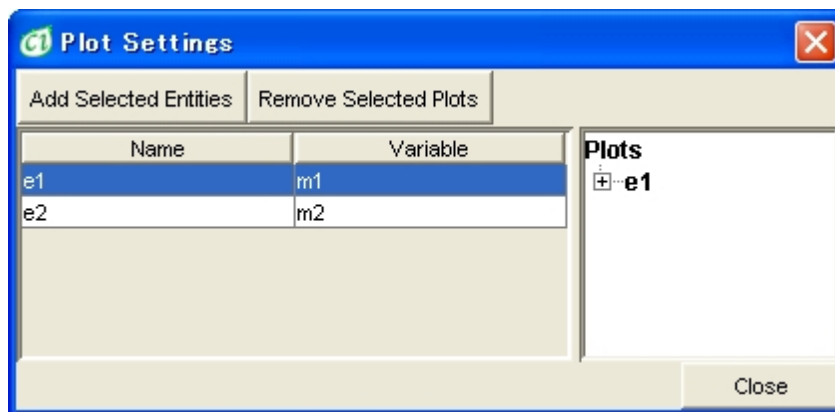









Figure 77

6.2.4 Run Simulation

Once the setup described in the previous section is completed, you can start and control the simulation using the VCR-like controls in the Simulation toolbar. The toolbar allows you to start  and pause  the simulation. Also, you can step through the simulation with the Step Play  button. The buttons  and  invoke simulation with animated tokens moving between entities. The simulation can be stopped at any time with the Stop and Initialize  button. These simulation commands are also available in the Simulation menu in the Menu Bar.

During the simulation, active components in the model are highlighted in red. You can also see the values of the entities updated during the run. Charts defined in the Chart Settings dialog are displayed and updated with the frequency specified by the Plot Update Interval option in the Simulation Settings dialog.

The simulation results for the logged Entities can be saved in a CSV (Comma Separated Values) file which can be opened outside Cell Illustrator in a text editor or a spreadsheet. After your simulation is completed press the Save Simulation Log  button. You will be prompted to enter the name for a CSV file that will store the log. The logging frequency is defined by the Log Update Interval option in the Simulation Settings dialog.

6.3 Viewing and Analyzing Simulation Results

6.3.1 Simulation Charts

Entity values in charts are color coded. Right click on a chart to open a pop up menu with options to customize the chart (Figure 78).

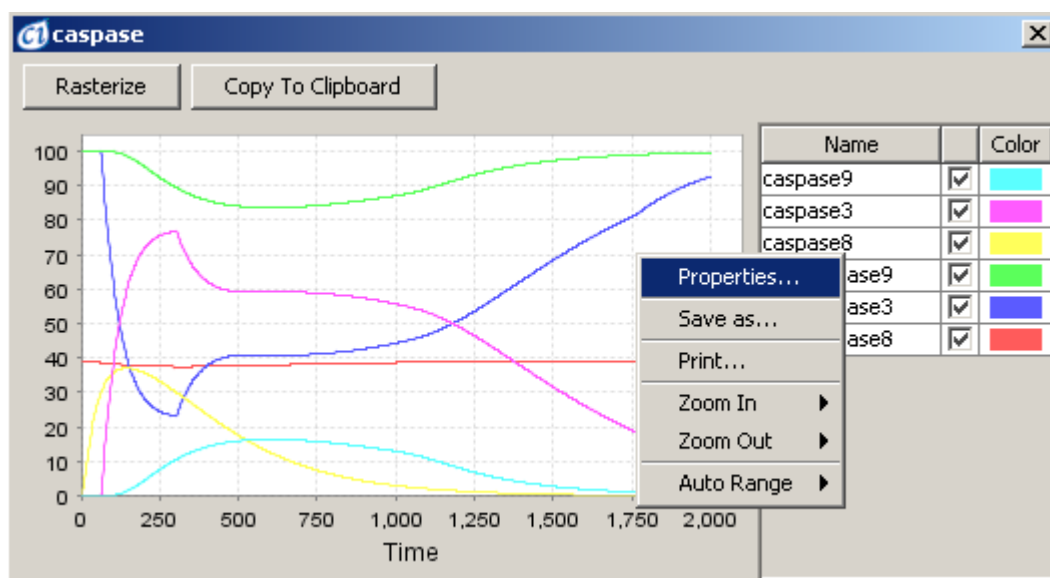

Figure 78

- Properties... — opens a dialog box, in which you can set the chart visualization details.
- Save as... — Turns on and off the tool tip for the graph. If the option is enabled, you can see the value of the data point once you move the mouse cursor over it.
- Zoom In/Zoom Out — Turns on and off the zoom in feature. You can drag the mouse cursor over an area in the chart to zoom into it.
- Auto Range — adjusts the range of x and y axis.

- Copy to Clipboard button — Copies the chart to the system clipboard. You can export the chart to another application, e.g., Microsoft Word or Excel, in this way.
- Entity List – enables you to change the visualization and color of each single entity plot.

6.3.2 Simulation History Dialog

For your model, you can run simulation many times, changing the simulation parameters or making corrections to the model itself. The Simulation History dialog allows you to view and manage all the simulation log files (CILs) that have been saved for the given model file.

- If the simulation results are logged, i.e., at least one entity or process is selected for logging (see [Simulation Log](#)), each simulation run is saved into a separate CI log file (CIL) along with the model representation at the time the simulation was done. A log file has an extension *.cil* and it is created in the folder *[project name].output*, where *[project name]* is the name of the Cell Illustrator model file. For example, logs for the Cell Illustrator *Apoptosis.gon* sample project are kept in the *Apoptosis.output* subfolder in the folder where the *Apoptosis.gon* file is located.

All the saved simulation logs are accessible in the Simulation History dialog box.

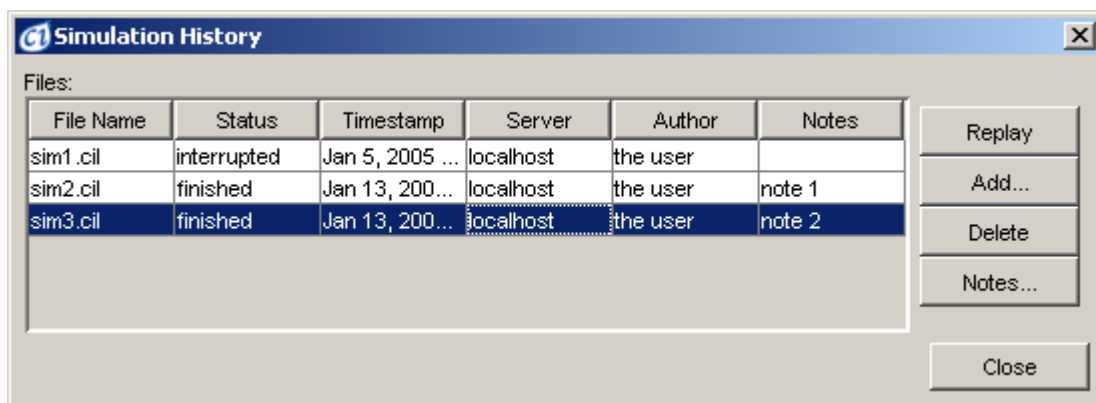

Figure 79

This dialog allows you for viewing and comparing the properties of each simulation run. The properties Author and Notes can be edited. You can also manage the list of logs by removing unwanted CIL files from the list or adding CIL files that have been calculated on different computers by other users.

With the Replay button you can open the selected log files for replay in the [Cell Illustrator Player](#) application. Only one CI Player application window can be opened at a time. If CI Player is already running at the time you press the Replay button, the selected files will be loaded into the CI Player application window.

6.3.3 Exporting Simulation Logs

Once a CI log file (CIL) is created, the simulation results can be exported to a CSV (Comma Separated Values) file using the File | Export | Simulation Log command. The CSV files can be viewed, analyzed and edited by a third party application, e.g., a spreadsheet or a text editor.

An exported CSV file will contain time series that remains in the in-memory log buffer of Cell Illustrator at the time the export command is executed. In case of a large log, the buffer may contain only a part of the log; the time series data is being saved to a hard disk while the simulation is running. You can set the size of the in-memory log buffer in the Preferences dialog in Cell Illustrator. To export the whole log, load it into the CI Player and execute the Export Simulation Log command there.

6.4 Running SECG Simulation

SECG (*Simulation Engine Code Generator*) is a new mode of running simulations in Cell Illustrator. SECG is based on the same HFPNe model as the standard simulation engine described above, however it is faster, more customizable and adds some viewing and running modes. The basic concept in SECG consists in generating a computer program which execution will perform the simulation. Also the SECG module allows exporting the source code of this program; this allows running the simulation from other program, and enables controlling the simulation behavior and data in a more precise way.

The simulation can be run using SECG module, by selecting *Simulation | Run SECG Simulation* in the menu. The simulation is performed outside the Cell Illustrator program, and many simulations can be done simultaneously. The drawback of SECG simulations is that they don't provide any control of the execution of the simulation, and may consume lot of computer resources, but at the same time those simulation are executed in much shorter time than the simulations which are run in the Cell Illustrator workspace. SECG can output the results of the simulation as charts and/or log file (this options are customizable from *Simulation | Setup SECG*). Moreover, SECG enables inserting reference data into the simulation plot (which enables visual comparison of simulation results versus reference data contained in CSV file), this simulation mode can be run by invoking *Simulation | Run Reference Simulation* .

Note: The *javac* compiler that is included in the JDK is required to run SECG simulations. The JDK (*Java Development Kit*) must be installed on your computer; JRE is not enough to run SECG.

6.4.1 Passing Parameter simulation

The SECG module offers a method for performing a serious of simulations (in a bulk) on the same model with varying the selected parameter value(s). This mode allows comparing the simulation results when initial parameters differ. It allows

checking, for example, how the amount of control entity influences the system or choosing the right value of some kinetic constant. The changing parameters are selected and the range of their values is defined in the *SECG Passing Parameter* dialog box. After that for each combination of parameter values a simulation is run. This mode is faster than running each simulation as a different SECG simulation and it is run outside the Cell Illustrator.

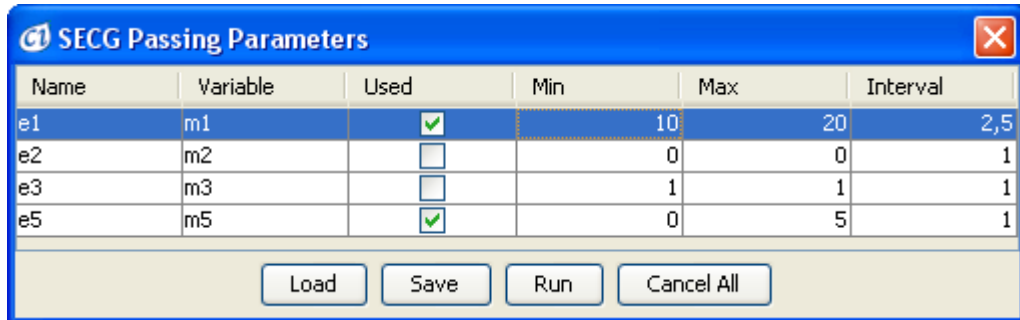

The results of Passing Parameter simulation are presented as 2D or 3D charts. After running Passing Parameter simulation a control panel window appears, which allows from comparing simulation results by selecting the chart type, and parameters values. The charts always present how the entities depend on one selected entity while the rest of the parameter values is fixed.

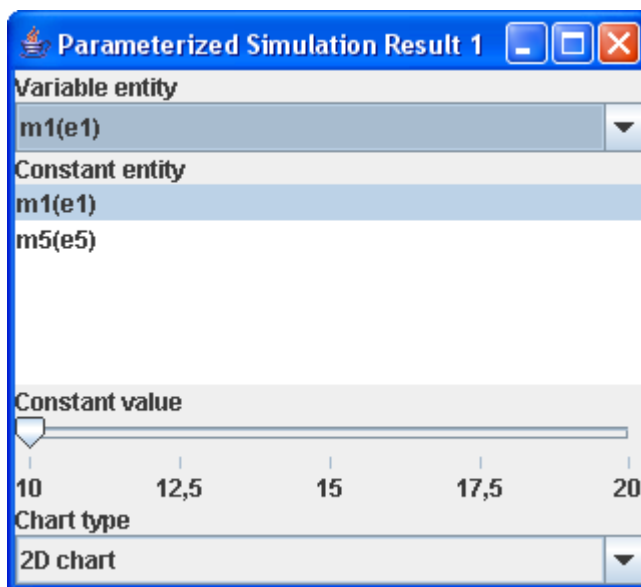

6.4.2 Advanced SECG topics

The SECG program is composed of two components, one holds common functionality the second contains information specific for the simulated model. The SECG allows the change and extension of the common module - see the *EngineBase* options in *Simulation | Setup SECG* menu. This enables the usage additional functions/scripts, or performing operations which would normally would be impossible in the Cell Illustrator, for example saving and using previous values of the entities.

The source code of the engine generated by SECG can be exported to file in Java or other languages. The source code file can then be edited, which allows for better control over the simulation. Also the simulation source code can be controlled and executed in other program, which is useful for performing parameter optimization, or generating some advanced statistics from the engine run.

The exact reference for advanced usage, which contains description how the SECG framework works and detailed information of the content of each source code file is obtainable from Masao Nagasaki (masao@ims.u-tokyo.ac.jp or check <http://www.csml.org>).

Note: Profiting from the SECG engine possibilities to the full extent requires some software development skills.

6.5 Remote Simulation Servers

In Cell Illustrator, simulations are normally executed at your desktop machine using the default *simulation engine* which is tightly integrated with the remaining program components. These local simulations are interactive, i.e., the canvas is updated during the simulation run, and you may pause or move through the simulation. However, you can neither edit another model nor run another simulation in this mode. Thus, running simulations in your CI Workspace is recommended for debugging purposes and simulations that are not time consuming. For large models and lengthy simulations, sending a simulation job to a remote server is recommended. The *Cell Illustrator Server (CI Server)* is a companion product of Cell Illustrator and it is not a part of the standard CI package. Hence, this option is available only to users who have additionally purchased the CI Server. One server can be accessed by multiple users of the Cell Illustrator desktop package, or alternatively one can connect to more than one CI Server from your desktop. The remote server mode of running simulations is also useful if you intend to run many simulations in parallel. The server mode of simulations does not drain upon the resources of your computer, so you may continue to work with CI or other applications after submitting many simulations to a server.

Technically, CI Server is a *web service* installed at an Apache Tomcat web server. A remote simulation is completed in three steps: (1) upload the model input file to the server, (2) execute the simulation using the engine installed at the server, and (3) download the output file ([Simulation Log](#)). The CI Server installation procedure requires the skills of an IT system administrator and is described in the **Cell Illustrator Server Installation Manual**. Once the CI Server is installed, you need to configure your CI Workspace to access it.

6.5.1 Registering a CI Server

To submit simulations to a server, you must add it to the list of servers in your CI Workspace. For this, you will need to specify the URL address of the respective web service. Optionally, if the web service is password protected, you will also need to specify the authorization data (user name and password). The menu command *Simulation | Setup Servers* opens the *Setup Servers* dialog, in which you can view and manage the list of servers. With the *Test* button you can confirm that the selected *CI Server* is accessible.

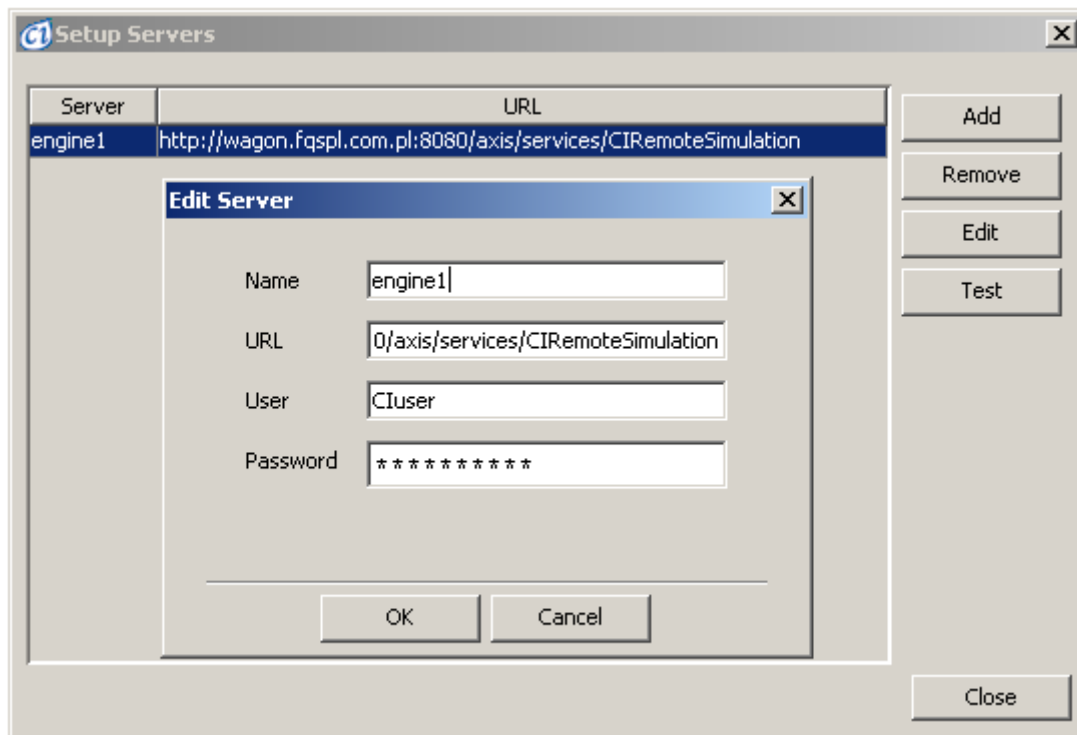

Figure 80 Server Setup

6.5.2 Running a Simulation Job at a CI Server

To submit the model in the active canvas for simulation at a remote server, select the server name in the list available at the *Simulation | Send to Server* menu option. The simulation jobs starts and you can view its progress in the *Submitted Simulations* dialog that opens up. To interrupt a running simulation, press the *Stop* button. After this command the program will attempt to stop the simulation at the server and download the output files of the interrupted job. The *Delete* button removes the simulation from the list without downloading the output files.

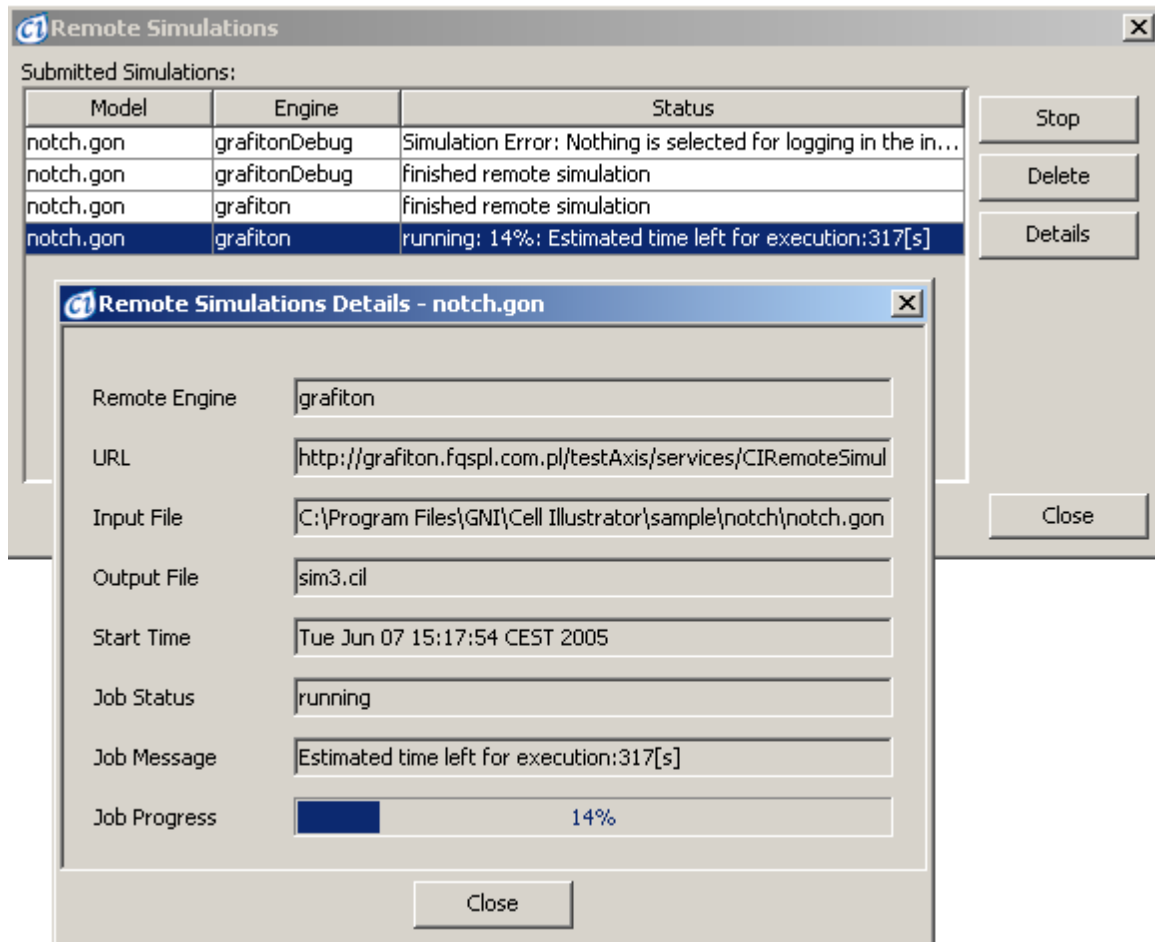

Figure 81 Submitted Simulations

After a remote simulation job is completed, its log file is downloaded from the server, and saved in the output directory of the model. The simulation log appears in the list in the [Simulation History Dialog](#). You can open, view and analyze the simulation log in [Cell Illustrator Player](#) the same as you can with any other log file.

When the download of the log file is completed, the message “Remote simulation finished” is displayed to the user. In this dialog box you are prompted whether to open the log with CI Player.

6.6 Customized Simulation Engine

CI Server uses the standard simulation engine supplied with Cell Illustrator. However, an advanced CI user who would like to integrate his own simulation program into CI can do so by replacing the default engine at the server with his own program. The user engine must fulfill the following requirements:

- Read the input file from a CI model file, i.e, the model must be in the CSML format
- Write the simulation log file in the CSML format to the output directory
- Write the simulation status file in a format compatible with the CI Server
- Check for the stop file (optionally)

For more information see the **Cell Illustrator Server Installation Manual**.

7 Tools for Model Analysis

7.1 Navigator

For a large model, the Navigator dialog (Figure 82) provides a convenient way to locate and display in the canvas window a desired part of the model. The Navigator displays a small view of the entire model, with a green rectangle marking the portion of the model currently shown in the active canvas. You can drag this rectangle around in order to navigate the model in the canvas window.

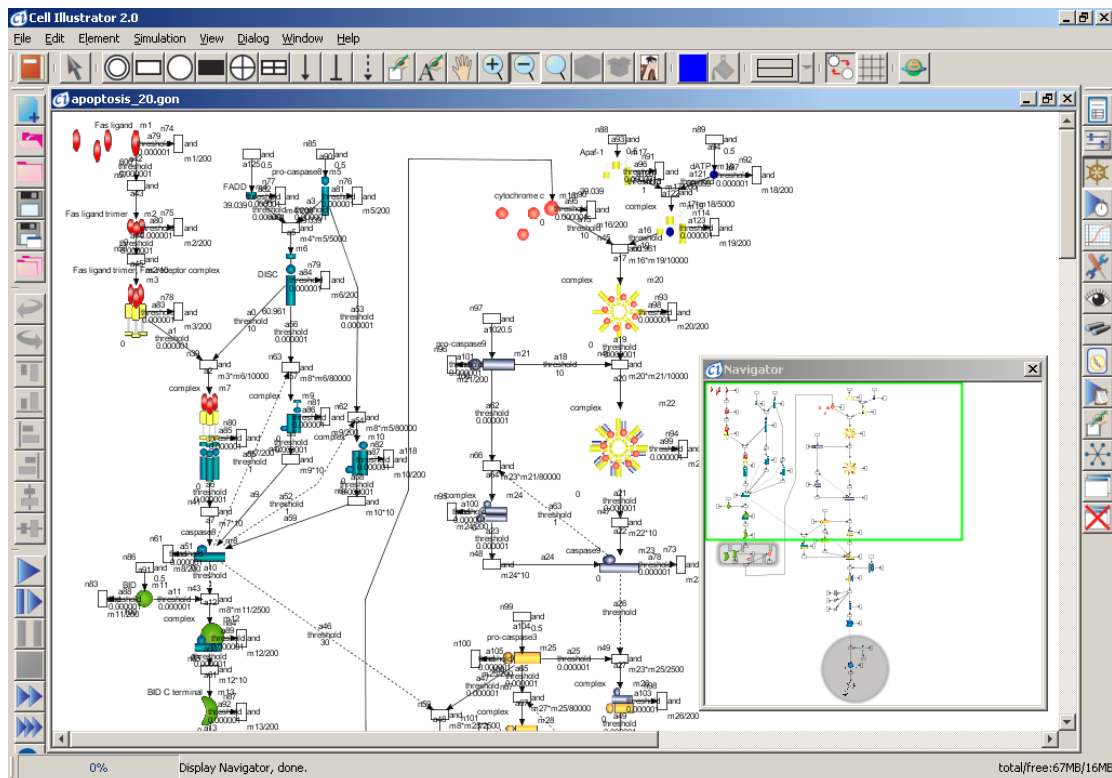

Figure 82

7.2 Finder

With the Finder dialog, you can search for specified elements in the active canvas (Figure 83). As with the Navigator, the Finder becomes very useful when the model in the canvas is large or very complicated.

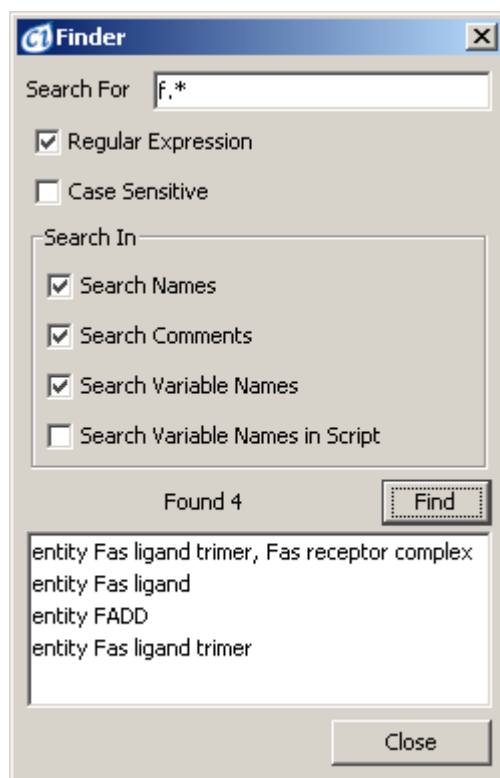

Figure 83

7.3 Print and Print Area

In CI, you can output the whole canvas, a part of active canvas, or the simulation charts to a printer or an image file in the Postscript, PNG or JPEG format (Figure 84). This functionality is available via Print and Print Area options in the File menu.

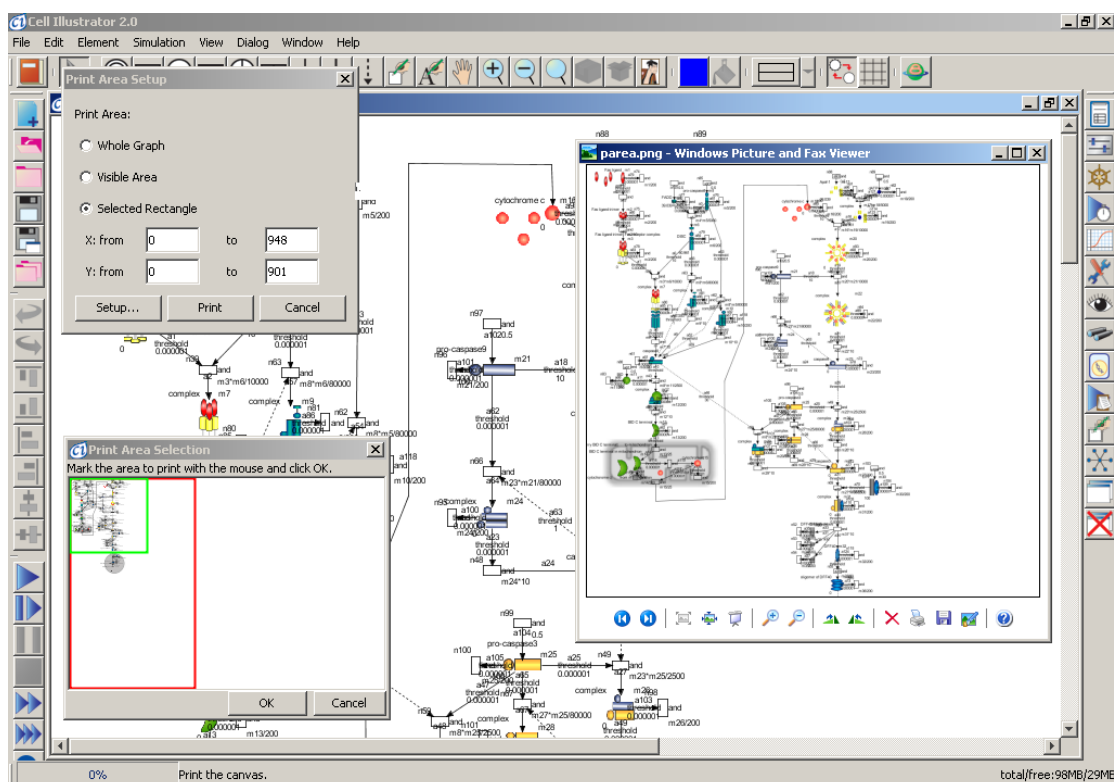

Figure 84

7.4 Export Options

Analysis of model structure and simulation results can be also carried out outside Cell Illustrator, with third-party tools. The options Export | Entity List, Export | Process List and Export | Connector List in the File menu store respective data in a file in the CSV (Comma Separated Values) format. Such a file can be later uploaded to a spreadsheet, for example. The option Export | CSO Model (available since version 4.0) allows to export model to Cell System Ontology 3.0 format.

The screenshot shows the Cell Illustrator 2.0 interface with a complex biological model diagram. The 'File' menu is open, and the 'Export' option is selected, leading to a submenu where 'Entity List' is chosen. A Microsoft Excel spreadsheet titled 'ent.csv' is open in the foreground, displaying the exported data. The spreadsheet has the following structure:

Name	Type	Variable	Initial Value	Event
1	Fas ligand	Double	m3	0
2	pro-caspas	Double	m5	39.039
3	DISC	Double	m6	60.961
4	complex	Double	m7	0
5	caspase8	Double	m8	0
6	BID	Double	m11	100
7	BID C term	Double	m13	0
8	cytochrom	Double	m16	0
9	Apaf-1	Double	m17	39.039
10	dATP	Double	m18	39.039
11	complex	Double	m20	0
12	pro-caspas	Double	m21	100
13	complex	Double	m22	0
14	caspase9	Double	m23	0
15	pro-caspas	Double	m25	100

The status bar at the bottom of the Cell Illustrator window indicates '0% Export entity list, done.' and 'total/free:98MB/26MB'.

Figure 85

8 Making Complex Models

This chapter presents features of CI that are especially useful for large-scale modeling.

8.1 Grouping and Ungrouping

When editing a model, it is often convenient to treat a group of elements in the canvas as one element. This can be accomplished with the Group command. This command is accessible in three ways: via the popup menu in the canvas, Element | Group in the main menu and the Group icon in the Edit toolbar. Once elements are grouped you can select and move them around easily just as one element. The grouped elements can be ungrouped with the Ungroup operation. Again, there are three ways to ungroup elements: via the popup menu in the canvas, Element | Ungroup in the main menu and the Ungroup icon in the Edit toolbar.

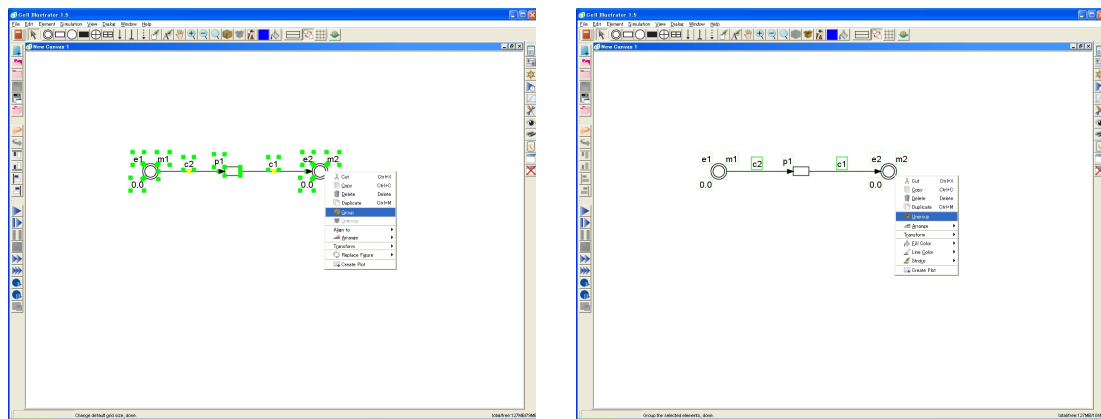

Figure 86

8.2 Hierarchization

The Import options in the File menu and the canvas popup menu offer several ways to reuse your existing models as building blocks for creating a more complex model. Import | Model copies elements from a selected file into the model currently edited in the canvas. Import | As Group does the same with the following exception; the imported elements are enclosed into one group element after the import operation. Finally, Import | As Object inserts the model from a specified file as a singular object that is treated as one not solely for editing purposes but for simulation purposes as well. In other words, Import | As Object allows you to build a hierarchy of models, where a high-level model contains objects representing lower-level models. The concept of model hierarchy is demonstrated in the example below.

Once a model is created in a canvas (Figure 87 (a)) and saved in a file, it can be loaded (Figure 87 (b)) and reused in a new canvas (Figure 87 (c) and Figure 87 (d)) as one element referred to as a hierarchical object. In the new canvas, processes can access only those entities inside the hierarchical object that have the Public property set to the "on" value. The Public property can be set in the original file in the Element Lists dialog or the Element Settings dialog. In the example, entities p1 and p2 are public. Multiple copies of a model can be loaded as objects onto a canvas.

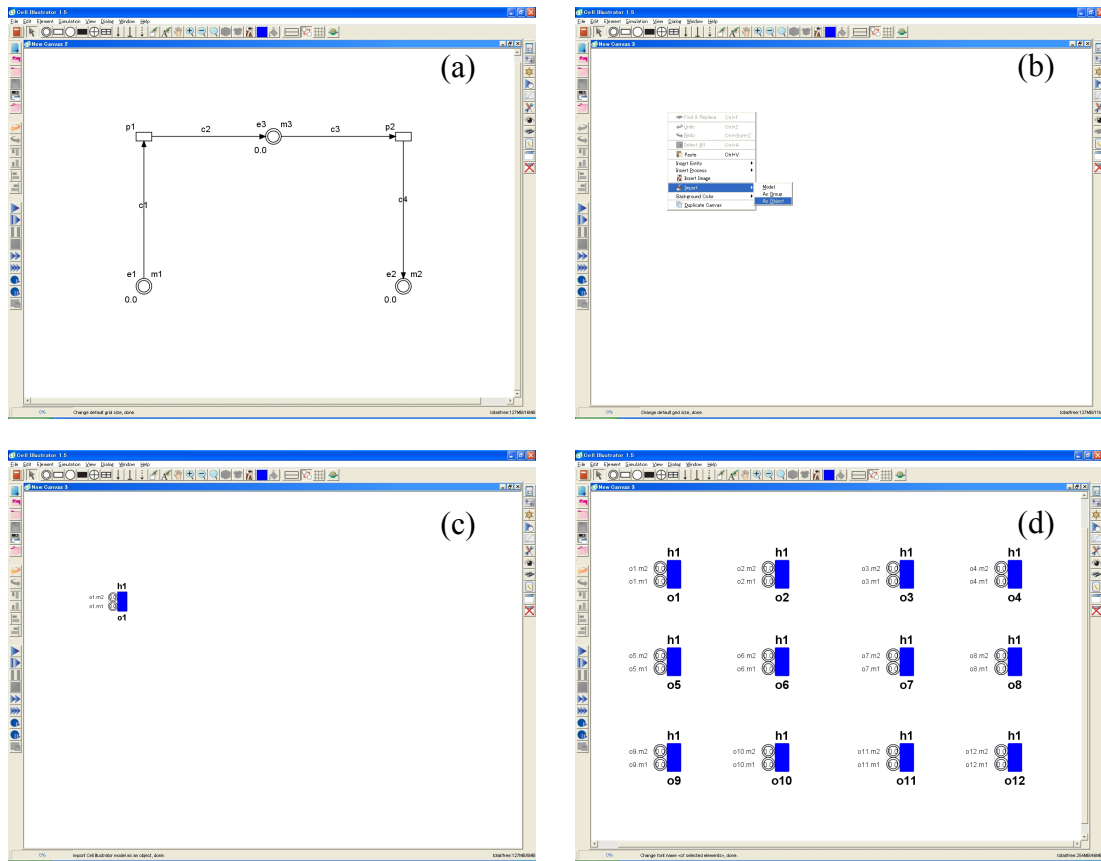

Figure 87: Usage of the hierarchization.

8.3 Edit Parts

The Edit Parts button is the leftmost button in the Edit toolbar. With this button, you can register a model file as a reusable item. Once registered, the model is accessible in the drop-down list and the elements in the file can be imported onto a canvas in the same way the command Import | Model works. With Edit Parts, you can organize a repository of frequently reused models. Cell Illustrator comes with several pre-registered parts to demonstrate this functionality.

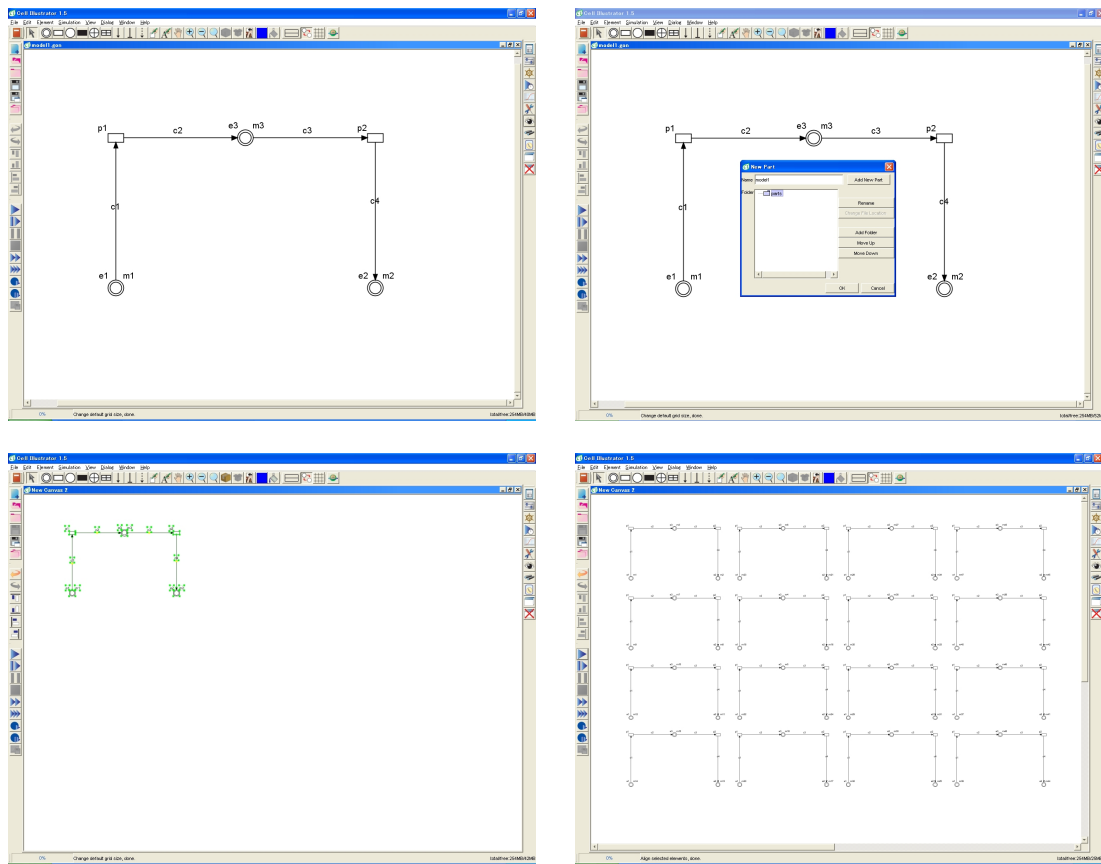



Figure 88. Edit Parts usage.

8.4 BioPACS

BioPACS is a Web system that converts metabolic pathway maps from the KEGG Web site to the XML file format used by CI [9, 12]. To connect to BioPACS, select the option File | Import | BioPACS or click on the  icon in the Edit toolbar. This opens the KEGG-BioPACS dialog. Select a KEGG map name and click on the Download button to convert it with the BioPACS tool and open in Cell Illustrator as a new canvas (Figure 89).

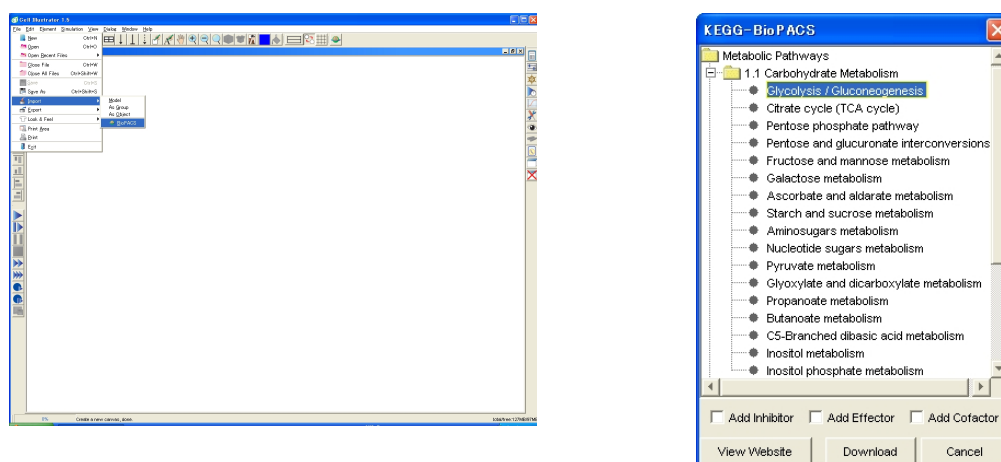

Figure 89. Importing KEGG maps with BioPACS.

8.5 Import of CellML or SBML models

CellML (www.cellml.org) and SBML (www.sbml.org) are widely used XML file formats for representing mathematical relationships in biological models.

In Cell Illustrator you can import models from CellML/SBML files into the CI workspace. During the import operations the models are converted to CI models and can be edited, analyzed, simulated, saved as any other models.

SBML/CellML models differ from the CI ones. E.g. SBML uses differential equations for representing relationships between entities, while CI use the Petri Net model. Therefore the conversion process has the following limitations:

- not all SBML models can be imported to CI
- the simulation results might differ, for a SBML model imported to CI.

It is recommended to run a simulation after a successful model import to verify whether the results of the converted model are identical to the simulation results of the original CellML model. Before running the simulation, the user should check and set the proper *Simulation Time* and *Sampling Interval* in the Simulation Settings dialog box.

8.6 Import of CSO and BioPAX models

Cell System Ontology 3.0 (CSO3.0 – www.csml.org/online-services/csml-30-ontology/) is an OWL format for storing biopathways information. It is based on CSML3.0, which makes it a very complex and powerful format.

BioPAX level 2 (www.biopax.org) is most popular ontology for storing biological pathways data. BioPAX Level 2 covers metabolic pathways, molecular interactions and protein post-translational modifications.

In Cell Illustrator you can import models from CSO and BioPAX files into CI workspace. During the import operations the models are converted to CI models and can be edited, analyzed, simulated, saved as any other models.

Each model opened in the workspace can be exported to CSO ontology.

9 Cell Illustrator Player

Once a CI log file is created during a simulation, it can be opened in CI Player application for replaying and detailed analysis.

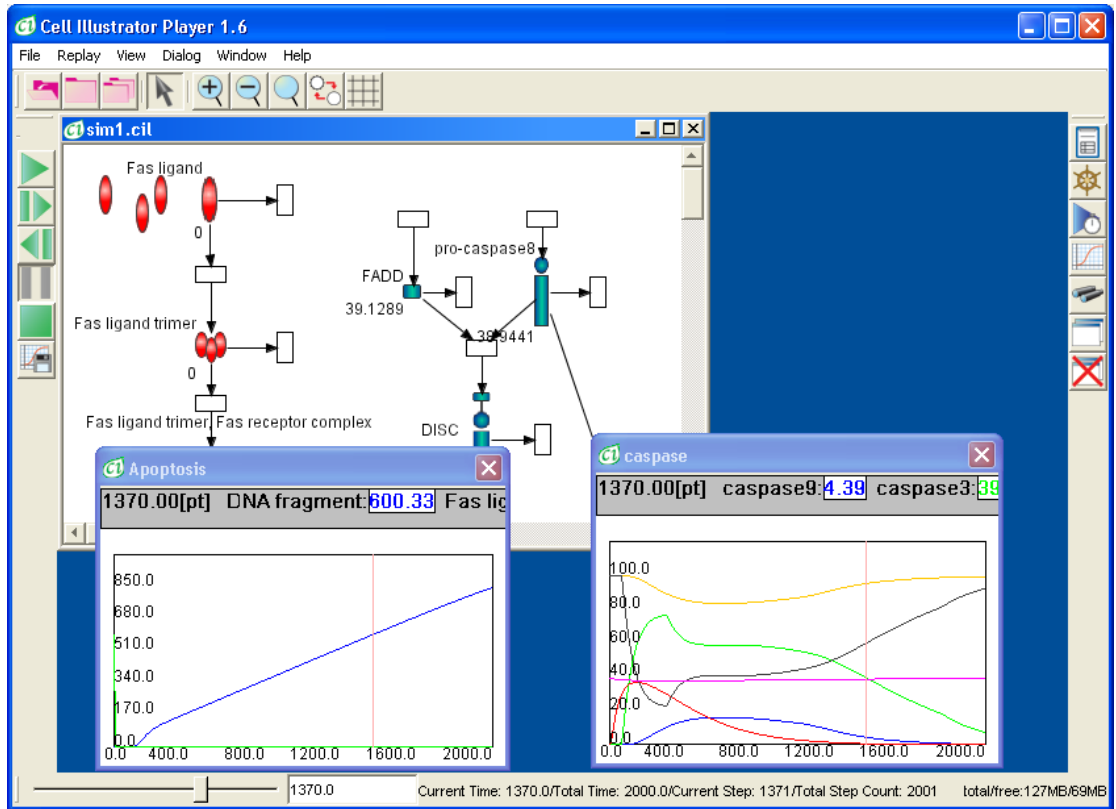

Figure 90. CI Player Workspace and Charts.

The main window of CI Player very much resembles the Workspace window in Cell Illustrator. However, instead of the Simulation menu and toolbar of Cell Illustrator, CI Player has the Replay menu and toolbar with commands for moving forward and backward over the time series in the log. The model state (entity values and process status) at a given simulation time point is visualized in the CI Player canvas window. On the other hand, charts in CI Player show entity value changes over the whole simulation period, with a vertical bar indicating the time point visualized in the canvas.



Figure 91. Process state indication in CI Player, from left to right: *firing*, *waiting* and *not-firing*

One advantage of replaying the simulation from a log as opposed to rerunning it in Cell Illustrator is the capability to deterministically repeat the simulation even for a model of stochastic nature. Also, you can quickly navigate to a specific part of simulation and step through it forwards and backwards for debugging purposes. For more details, please refer to the CI Player online help and CI Player Reference Manual. You can open them from the CI Player Help menu.

10 Cell Animator

The Cell Animator provides a platform to animate the biological pathways modeled with the Cell Illustrator. Please refer to Cell Animator User Manual for details.

Appendix A: Tutorial—Modeling Fas Ligand Induced Apoptosis

Apoptosis Induced by Fas Ligand

Apoptosis, programmed cell death, is known to participate in various biological processes such as development, maintenance of tissue homeostasis and elimination of cancer cells. Malfunctions of apoptosis have been implicated in many forms of human diseases such as neurodegenerative diseases, AIDS and ischemic stroke. Reportedly, apoptosis is caused by various inducers such as chemical compounds, proteins or removal of NGF. The biochemical pathways of apoptosis are complex and depend on both the cells and the inducers.

Fas-induced apoptosis has been studied in detail and its mechanism has been proposed as shown in Figure 1 [4]. We will represent this mechanism as a model with **Cell Illustrator**.

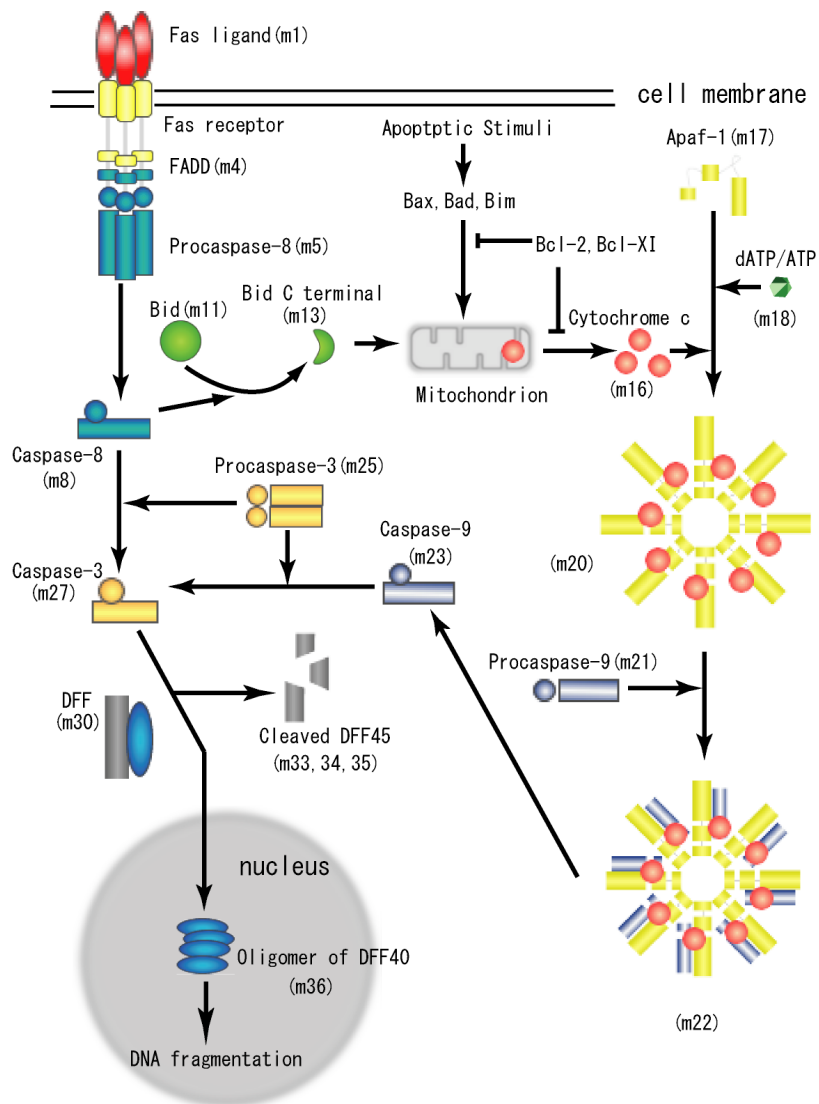

Figure 1: Proposed steps of apoptosis induced by Fas ligand: Fas ligands, which usually exist as trimers, bind and activate their receptors by inducing receptor trimerization. Activated receptors recruit adaptor molecules such as Fas-associating protein with death domain (FADD), which recruit procaspase 8 to the receptor complex, where it undergoes autocatalytic activation. Activated caspase 8 activates caspase 3 through two pathways; the complex one occurs when caspase 8 cleaves Bcl-2 interacting protein (Bid) and its COOH-terminal part translocates to mitochondria where it triggers cytochrome c release. The released cytochrome c binds to apoptotic protease activating factor-1 (Apaf-1) together with dATP and procaspase 9 and activates caspase 9. The caspase 9 cleaves procaspase 3 and activates caspase 3. The other pathway occurs when caspase 8 cleaves procaspase 3 directly and activates it. The caspase 3 cleaves DNA fragmentation factor (DFF) 45 in a heterodimeric factor of DFF40 and DFF45. Cleaved DFF45 dissociates from DFF40, inducing oligomerization of DFF40 that has DNase activity. The active DFF40 oligomer causes the internucleosomal DNA fragmentation, which is an apoptotic hallmark indicative of chromatin condensation. (Note, this is not a CI model.)

The pathways consist of several steps < where two different pathways from caspase 8 are assumed> and many molecules including Fas receptors, the caspase family which includes aspartic acid-dependent cysteine proteases and products of their zymogens; the Bcl-2 family which includes pro- and anti-apoptotic proteins, cytochrome c and DNA fragmentation factor. The apoptosis starts from the Fas ligand binding to Fas receptors and ends in the fragmentation of genomic DNA, which is used as a hallmark of apoptosis. Thus the amount of DNA fragmentation can be assumed to be proportional to the cell death.

We have designed a model through utilization of the known facts about the Fas-induced apoptosis pathways shown in Figure 1 and biochemical knowledge about reactions. Figure 2 shows the model representation that we have described with Cell Illustrator.

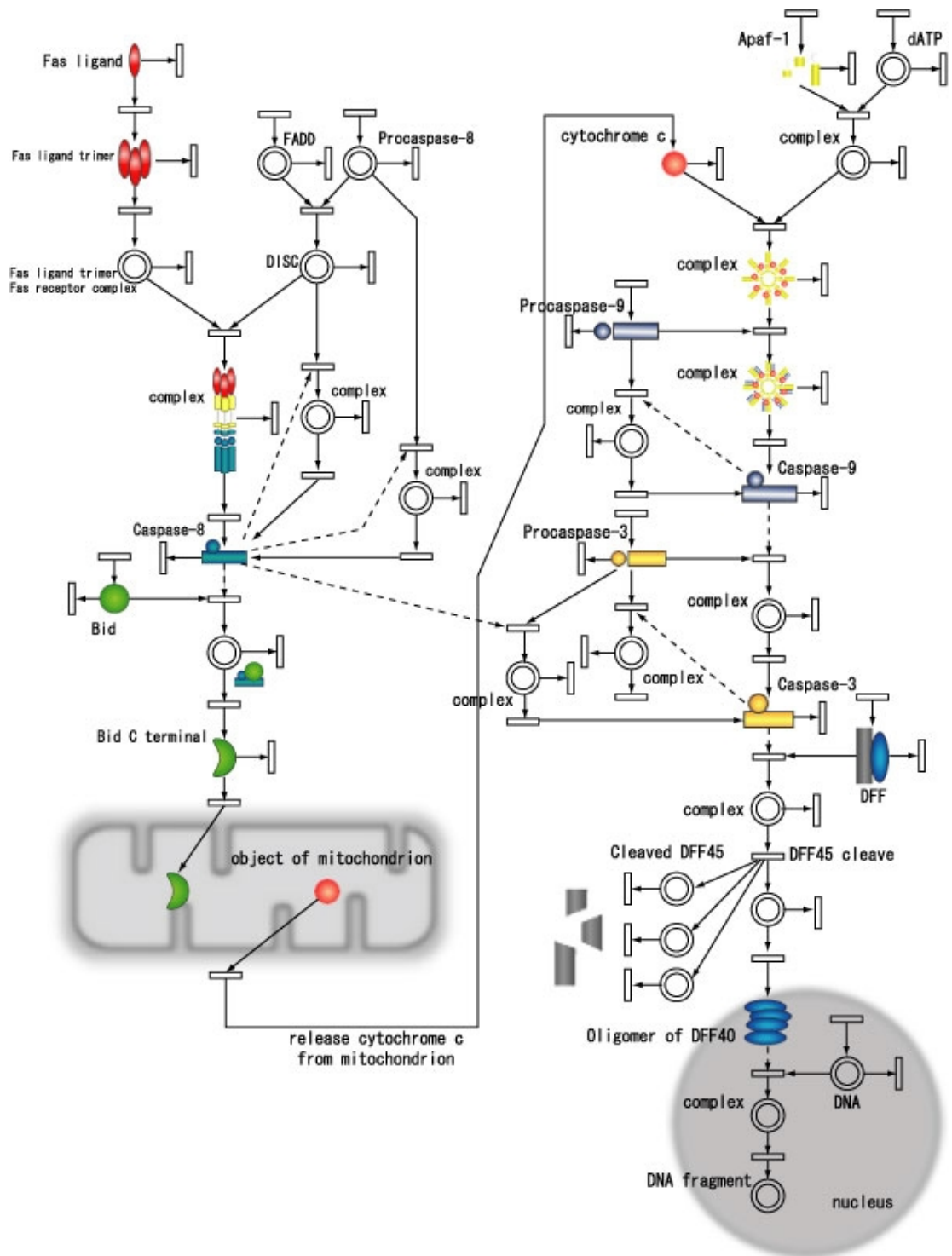

Figure 2: A CI model representing the Fas-induced apoptosis obtained from Figure 1: For Bid (m11), Procaspase-9 (m21), Procaspase-3 (m25), DFF (m30), DNA (m37), the initial concentration of each compound is assumed to be 100. On the other hand, for FADD (m4), Procaspase-8 (m5), Apaf-1 (m17), dATP/ADP (m18), when two compounds react together without the stimulation of apoptosis, the initial concentrations and the rate are assumed to be 39.039 and $m1 * m2 / 5000$, respectively to keep the stable state condition. Each compound is assumed to be produced by the rate of 0.5 (represented by a process without any incoming connector) and to degrade by the rate of its concentration divided by 200 (represented by a process without any

outgoing connector), which keeps its concentration at 100 under the stable state condition. This degradation rate also applies to other compounds in the network. The rate of other processes is determined roughly by following Table 1. Synthesis and catabolism processes are added in the model for all proteins. Autocatalytic processes are also added in the model to all caspases since they exist as proenzymes. The pathway from caspase 8 to caspase 3 is assumed when the caspase 8 concentration is over 30. Protease is often synthesized as a proenzyme (zymogen) and changed to active form by other enzymes or by itself. So the autocatalytic process is added to every caspase reaction.

Table 1: Functions assigned to continuous processes in the simulation of apoptosis induced by Fas ligand, where mA and mB represent the contents of the corresponding continuous entities.

Rate	Unimolecular reaction	Bimolecular reaction
Self-effacement	$mA/200$	
Oligomer	$mA/20$	$mA*mB/10000$
Monomer	$mA/10$	$mA*mB/5000$
Enzyme binding	$mA/5$	$mA*mB/2500$
Enzyme reaction	$mA*10$	

By using the apoptosis scheme modeled as a model, we simulated the amount of DNA fragmentation by varying the Fas ligand concentration and Figure 3 shows the simulated relationship. It shows that under very weak stimulation (very low amount of Fas ligand), DNA fragmentation does not occur since the stimulation stops at the intermediate point because of the assumption of degradation processes. With the increase of the stimulation, the reaction proceeds to the backward intermediates and DNA fragmentation (cell death) occurs finally, which increases with the increase of the Fas ligand concentration.

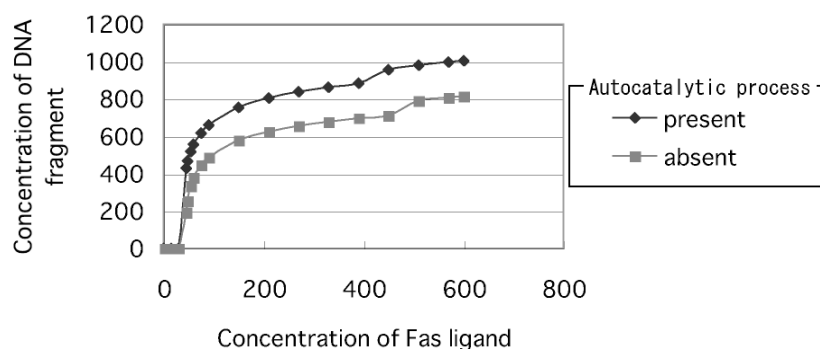

Figure 3: Simulated relationship between the amount of DNA fragmentation and the Fas ligand concentration: At higher concentration of Fas ligand, the direct pathway from caspase 8 to caspase 3 contributes to the fragmentation. To examine the effect of autocatalytic process of caspases, DNA fragmentation is simulated for both cases of the presence and absence in this process.

There are two pathways from activated caspase 8 to caspase 3, one through several steps including the cytochrome c release from mitochondria when the concentration of activated caspase 8 is low, and the direct one to caspase 3 when the concentration of activated caspase 8 is high [3]. We assume arbitrarily that the direct pathway starts when the concentration of activated caspase 8 is larger than 30. Reportedly the removal of the Bid by gene knockout method increases the resistance of liver cell apoptosis by Fas ligand, while it does not affect the apoptosis of thymus and embryonic cells. If the second pathway is included in the scheme, DNA fragmentation increases slightly, especially, when the Fas ligand concentration is high (Figure 3). However the detailed mechanisms of the selections of these two pathways from caspase 8 are still unclear and need to be studied in future.

Since the presence of autocatalytic process is proposed in caspases [2], it is included in our model (Figure 4), which increases the DNA fragmentation as shown in Figure 3.

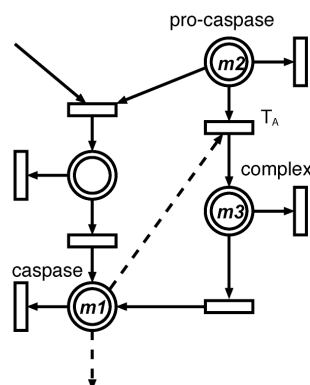

Figure 4: A model representation of autocatalytic process in Figure 2.

However, if the large rate of the autocatalytic process is assumed in the caspase reaction, the DNA fragmentation becomes independent of the Fas ligand concentration, which then disagrees with the experimental results. Therefore, we can guess that autocatalytic processes must be slow if they are present. To examine the effect of autocatalytic processes of caspases on the apoptosis by Fas ligand, DNA fragmentation is simulated when the stimulation by Fas ligand is stopped after a short period. Table 2 shows a simulation result where the apoptosis proceeds more with the increase of the autocatalytic rate of caspases even for a short period stimulation.

Table 2: DNA fragmentation at four autocatalytic rates of caspases ($rate0=0$, $rate1=mA*mB/80000$, $rate2=mA*mB/40000$, and $rate3=mA*mB/25000$), which are assigned to the process T_A in Figure 4. The stop time represents the period after that Fas ligand stimulation is stopped. The initial Fas ligand concentration is set to be $n = 600$. Variables mA and mB represent the contents of the continuous entities going into T_A .

DNA Fragmentation				
Stop time	rate0	rate1	rate2	rate3
10	0	0	0	1169
15	251	442	746	1862
20	417	581	885	2048

Figure 5 shows simulated time courses of the model in Figure 2 with CI. Some intermediates during apoptosis at three levels of Fas ligand concentrations are measured. These time courses might be useful to plan new experiments such as addition of inhibitors to various steps. However, it is necessary to estimate the realistic rates of each reaction by comparison with the experimental data. It is also necessary to add other pathways through the Bcl-2 family [1] or p53 to describe the real apoptosis held in various cells and by various inducers. CI is a very useful tool for biochemists to describe the complex biological pathways semi-quantitatively on a figure.

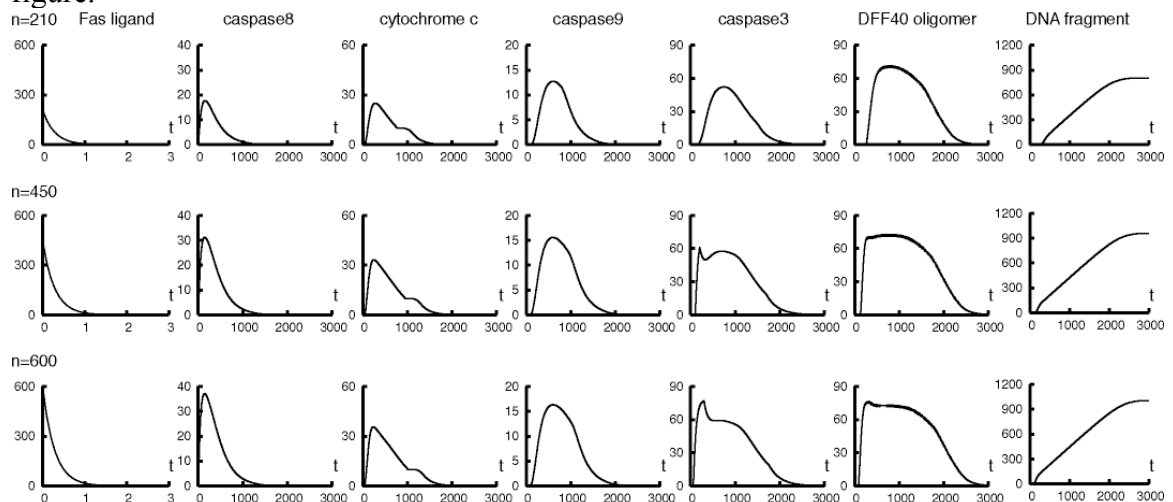

Figure 5: Simulated time courses of some intermediates during apoptosis for the Fas ligand concentration $n=210, 450, \text{ and } 600$.

(References)

[1]Harada, H. (1999) Regulation of apoptosis by BH3 domain only proteins. *Jikkenigaku*, **17**, 1603-1606.

[2]Hugunin, M., Quintal, L.J., Mankovich, J.A. and Ghayur, T. (1996) Protease activity of in vitro transcribed and translated *Caenorhabditis elegans* cell death gene (*ced-3*) product. *Journal of Biological Chemistry*, **271**, 3517-3522.

[3]Kuwana, T., Smith, J.J., Muzio, M., Dixit, V., Newmeyer, D.D., and Kornbluth, S. (1998) Apoptosis induction by caspase-8 is amplified through the mitochondrial release of cytochrome *c*. *Journal of Biological Chemistry*, **273**, 16589-16594.

[4]Nijhawan, D., Honarpour, N. and Wang, X. (2000) Apoptosis in neural development and disease. *Annual Reviews of Neuroscience*, **23**, 73-87.

Appendix B: Using Differential Equations in CI

In this example, the following differential equations are modeled with Cell Illustrator.

$$m1(t) = m1(0) - \frac{1}{10} \int_0^t m1(t) dt, \quad m2(t) = \frac{1}{10} \int_0^t m1(t) dt, \quad m1(0) = 10, m2(0) = 0$$

100.00[pt] m1: 0.00 m2: 10.00

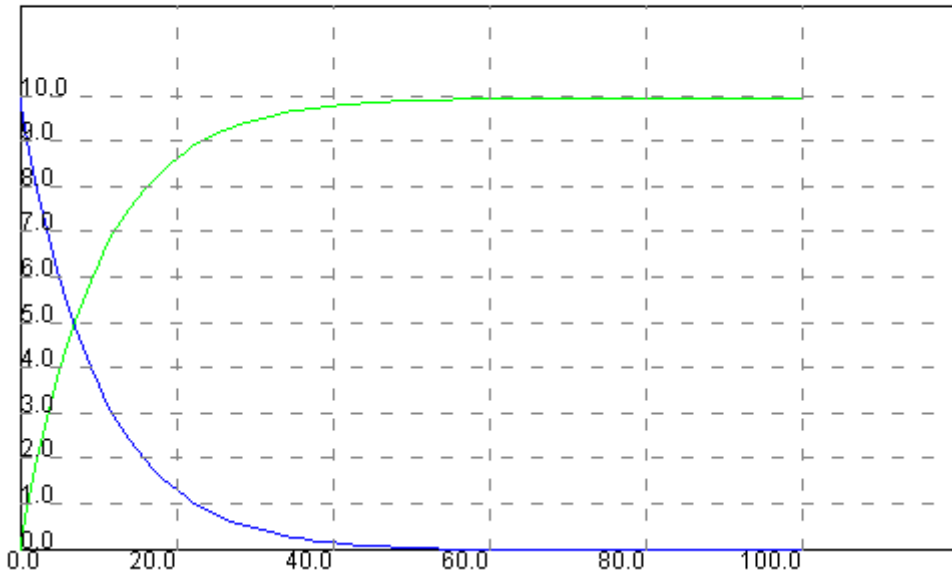

Figure 1 Differential equation results.

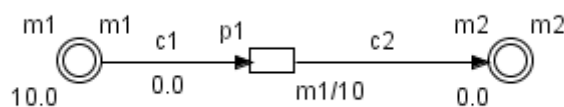

Figure 2

Figure 1 shows the differential equation results. For the model in Figure 2, the simulation results for runs with Sampling Interval equal to 0.1[pt], 1[pt] and 10[pt] are shown in Figure 3, Figure 4, and Figure 5, respectively. Comparing simulation results to those in Figure 1, you can easily notice that the smaller the sampling interval becomes, the more similar the simulation result is. Note that Cell Illustrator offers modeling features that are alternative to modeling with differential equations and allow the simulation of complicated systems in an easier way; (i) discrete behavior and continuous behavior can be mixed in one model in Cell Illustrator, (ii) the notion of delay can apply to discrete processes, (iii) activity and threshold concepts can be used in CI.

100.00[pt] m1:0.00 m2:10.00

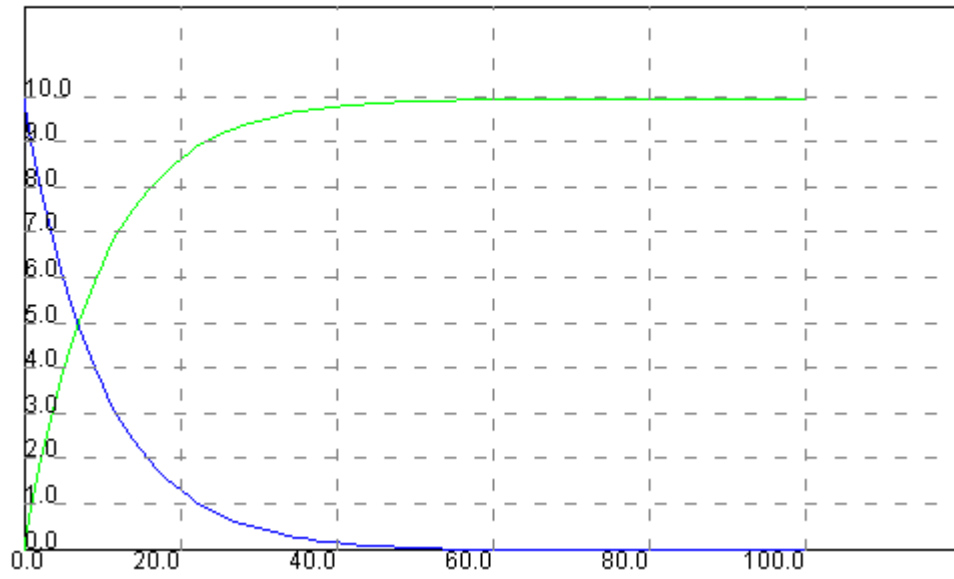

Figure 3 Sampling interval is 0.1[pt].

100.00[pt] m2:10.00 m1:0.00

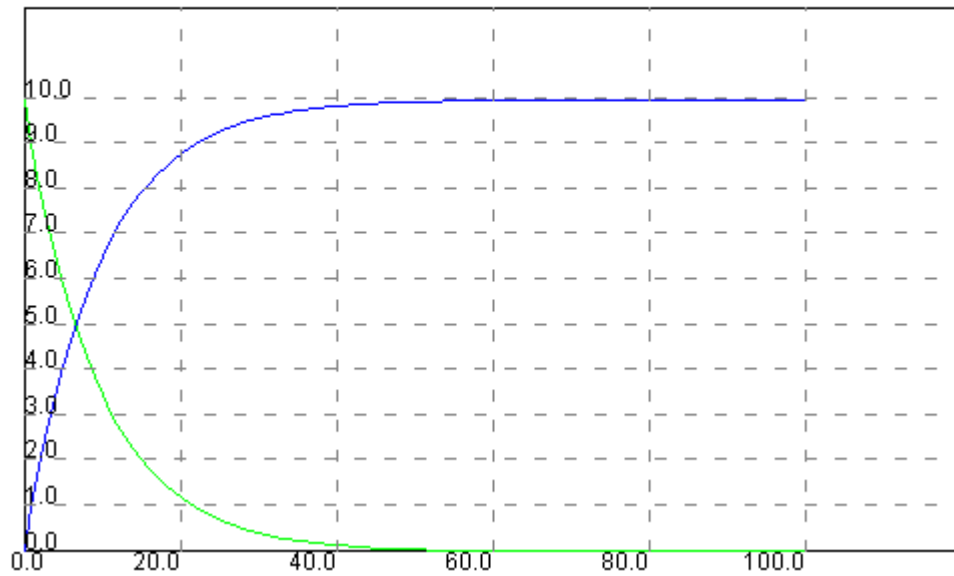

Figure 4 Sampling interval is 1[pt].

100.00[pt] m2:10.00 m1:0.00

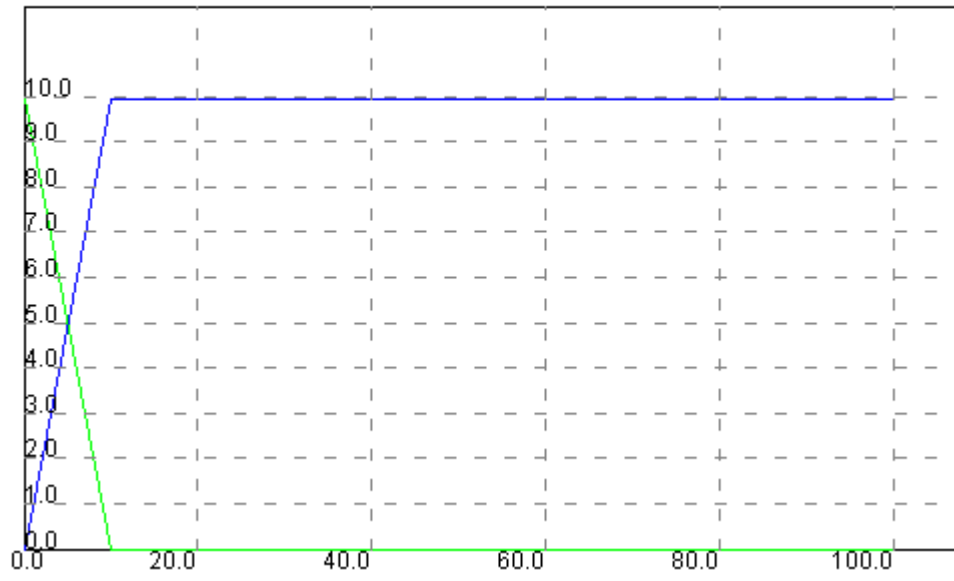

Figure 5 Sampling interval is 10[pt].

CI References

1. Doi A, Fujita S, Matsuno H, Nagasaki M, Miyano S (2004) Constructing biological pathway models with hybrid functional Petri nets. In *Silico Biology*, 4(3):271-291.
2. Doi A, Nagasaki M, Fujita S, Matsuno H, Miyano S (2004) Genomic Object Net: II. Modeling biopathways by hybrid functional Petri net with extension. *Applied Bioinformatics* 2:185–188
3. Matsuno H, Doi A, Hirata Y, Miyano S (2001) XML documentation of biopathways and their simulations in Genomic Object Net. *Genome Informatics* 12:54–62
4. Matsuno H, Doi A, Nagasaki M, Miyano S (2000) Hybrid Petri net representation of gene regulatory network. *Pacific Symposium on Biocomputing* 5: 341–352
5. Matsuno H, Fujita S, Doi A, Nagasaki M, Miyano S (2003) Towards biopathway modeling and simulation. In: 24th International Conference on Applications and Theory of Petri Nets (ICATPN 2003). Volume 2679., *Lecture Notes in Computer Science*, pp 3–22
6. Matsuno H, Murakami R, Yamane R, Yamasaki N, Fujita S, Yoshimori H, Miyano S (2003) Boundary formation by notch signaling in *Drosophila* multicellular systems: experimental observations and gene network modeling by Genomic Object Net. *Pacific Symposium on Biocomputing* 8:152–163
7. Matsuno H, Tanaka Y, Aoshima H, Doi A, Matsui M, Miyano S (2003) Biopathways representation and simulation on hybrid functional Petri net. In *Silico Biol.* 3:389–404, http://www.bioinfo.de/isb/toc_vol_03.html/.
8. Nagasaki M, (2004) A Platform for Biopathway Modeling/Simulation and Recreating Biopathway Databases Towards Simulation, Ph.D Thesis, The University of Tokyo, http://genomicobject.net/pub/nagasaki_phd.pdf.
9. Nagasaki M, Doi A, Matsuno H, Miyano S, (2003) Recreating biopathway databases towards simulation. In: *Computational Methods in Systems Biology*. Volume 2602 of *Lecture Notes in Computer Science.*, Springer-Verlag, pp 191–192
10. Nagasaki M, Doi A, Matsuno H, Miyano S, (2004) A versatile Petri net based architecture for modeling and simulation of complex biological processes. *Genome Informatics* 15(1): 180-197.
11. Nagasaki M, Doi A, Matsuno H, Miyano S, (2004) Genomic Object Net:I. A platform for modeling and simulating biopathways. *Applied Bioinformatics* 2:181–184
12. Nagasaki M, Doi A, Matsuno H, Miyano S, (2004) Integrating biopathway databases for large-scale modeling and simulation. In: *The Second Asia-Pacific Bioinformatics Conference*. Volume 29 of *Conferences in Research and Practice in Information Technology.*, Australian Computer Society, pp 43–52
13. Nagasaki M, Doi A, Matsuno H, Miyano S, (2005) *Bioinformatics Technologies*, Chen, Yi-Ping Phoebe Ed, Springer Press, 179-243, ISBN 3540208739.

(Note) Genomic Object Net is the research version of Cell Illustrator. When Cell Illustrator is cited, please cite the literature [11].